



DMM3500BT

User Manual



Intertek



EN All New Designed Bluetooth DMM

 **Safety Information**















Understand and follow operating instructions carefully. Use the meter only as .

 **WARNING**

- If the equipment is used in a manner not specified by the manufacturer, the protection provided by the equipment may be impaired.
- Always use proper terminals, switch position, and range for measurements.
- To reduce the risk of fire or electric shock, do not use this product around explosive gas or in damp locations.
- Verify the Meter operation by measuring a known voltage. If in doubt, have the Meter serviced.
- Do not apply more than the rated voltage, as marked on Meter, between terminals or between any terminal and earth ground.
- To avoid false readings that can lead to electric shock and injury, replace the battery as soon as low battery indicator blinks.
- Avoid working alone so assistance can be rendered.
- Do not use the Tester if the Tester is not operating properly or if it is wet.
- Individual protective device must be used if hazardous live parts in the installation where the measurement is to be carried out could be accessible.
- Disconnect the test leads from the test points before changing the position of the function rotary switch.
- Never connect a source of voltage when the function rotary switch is not in voltage position.
- When using test leads or probes, keep your fingers behind the finger guards.
- Use caution with voltages above 30 Vac rms, 42 Vac peak, or 60 Vdc. These voltages pose a shock hazard.
- Remove test lead from Meter before opening the battery door or Meter case.
- DO NOT USE the test leads when the internal white insulation layer is exposed.
- DO NOT USE the test leads above maximum ratings of CAT. environment, voltage and current, that are indicated on the probe and the probe tip guard cap.
- DO NOT USE the test leads without the probe tip guard cap in CAT III and CAT IV environments.
- Probe assemblies to be used for MAINS measurements shall be RATED as appropriate for MEASUREMENT CATEGORY III or IV according to IEC 61010-031 and shall have a voltage RATING of at least the voltage of the circuit to be measured.
- Only replace the blown fuse with the proper rating as specified in this manual.

- Do not attempt a current measurement when the open voltage is above the fuse protection rating. Suspected open voltage can be checked with voltage function.
- Never attempt a voltage measurement with the test lead inserted into the A input terminal.
- Disconnect circuit power and discharge all high-voltage capacitors before testing resistance, continuity, diodes, or capacitance.

Symbols as marked on the Meter and Instruction manual

	Risk of electric shock		Low battery
	See instruction manual		Fuse
	DC measurement		Earth
	AC measurement		Conforms to EU directives
	Bluetooth		Both direct and alternating current
	Equipment protected by double or reinforced insulation		
	Application around and removal from hazardous live conductors is permitted		
	Do not discard this product or throw away.		
	Attention! Magnets might affect the correct functioning of cardiac pacemakers and implanted defibrillators. As a user of such medical devices, keep a sufficient distance to the magnet.		

Unsafe Voltage

To alert you to the presence of a potentially hazardous voltage, when the Tester detects a voltage ≥ 30 V or a voltage overload (OL) in V, mV, PV. The  symbol is displayed.

Maintenance

Do not attempt to repair this Meter. It contains no user serviceable parts. Repair or servicing should only be performed by qualified personnel.

Cleaning

Periodically wipe the case with a dry cloth and detergent.
Do not use abrasives or solvents.

Introduction

The Meter Description

Front Panel Illustration

1. Volt Seek Light
2. 6,000 count digital display
3. Push-buttons.
4. Rotary switch for turn the Power On / Off and select the function.
5. Input Terminal for Multi-function.
6. Common (Ground reference) Input Terminal.
7. Input Terminal for A.

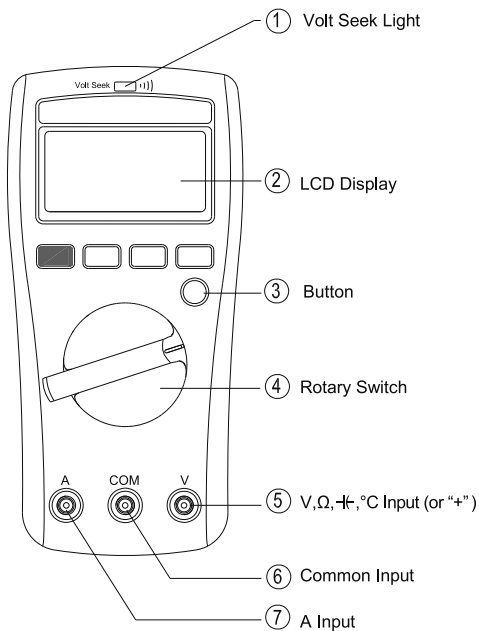

Making Basic Measurements

Preparation and Caution Before Measurement

! Observe the rules of **!** Warnings and **!** Cautions.

! CAUTION

When connecting the test leads to the DUT (Device Under Test) connect the common test leads before connecting the live test leads ; when removing the test leads, remove the live test leads before removing the common test leads.

Measuring Voltage

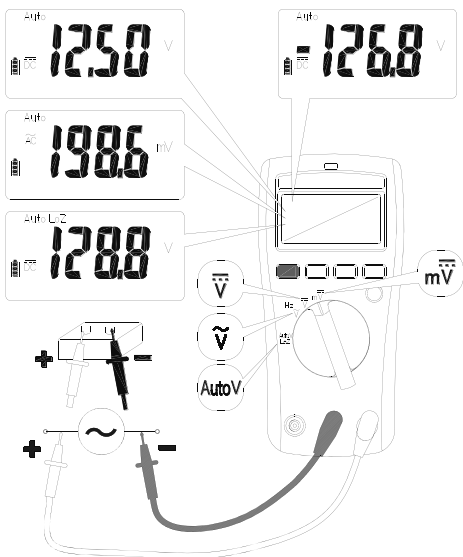

Dial the switch to select the measuring function.

! CAUTION

Do not use the LoZ mode to measure voltages in circuits that could be damaged by this mode's low impedance.

Measuring Current

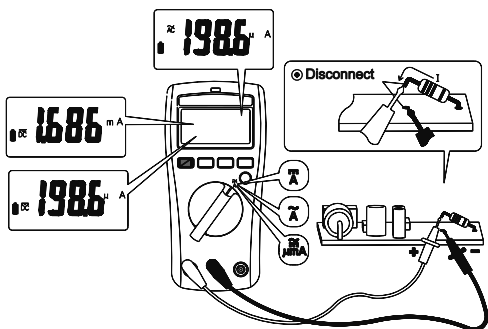

Dial the switch and press the Function button to select the measuring function.

Measuring Capacitance / Diode

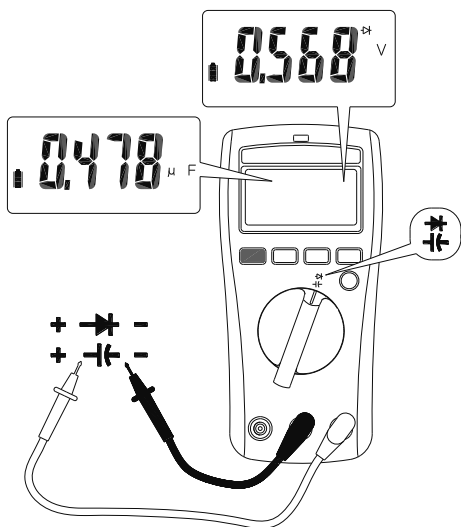

Dial the switch and press the Function button to select the measuring function.

Measuring Continuity / Resistance

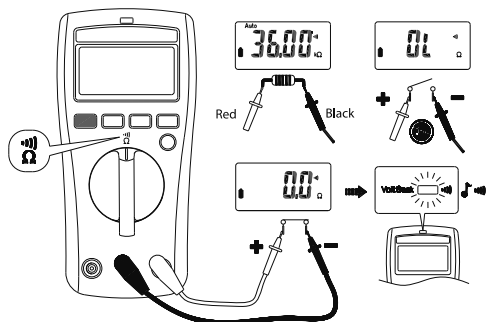

Dial the switch and press the Function button to select the measuring function.

Measuring Temperature °C / °F

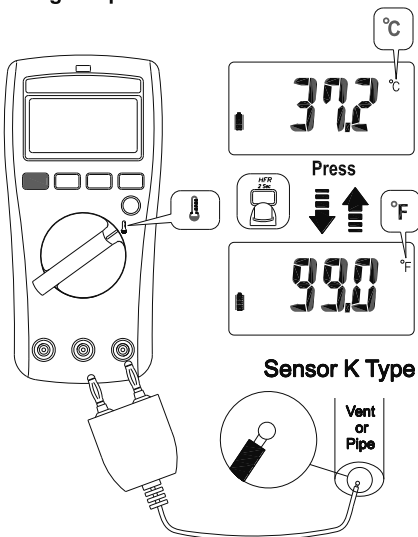

Dial the switch and press the Function button to select the measuring function. (°C / °F)

Volt Seek

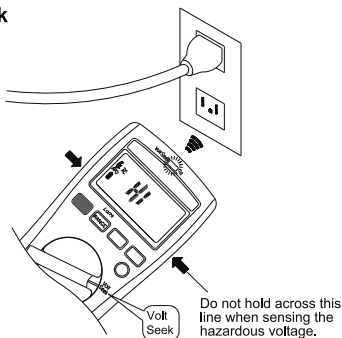

Dial the switch to select the measuring function.

Warning

The Volt Seek LED indicates the electric field. If the Volt Seek LED is not on, voltage could still be present.

Using the Function

Switch Position	Function
\tilde{V}	\tilde{V} → Hz
\tilde{A}	\tilde{A} → Hz
$\approx \tilde{A}$	$\approx \tilde{A}$ → \tilde{A} → Hz
Ω	Ω →
⎓	⎓ → ⎓
$\mu\tilde{A}$	$\bar{\mu}A$ → $\tilde{\mu}A$
°C	°C → °F

Press the Function button to change the function on the same switch position.

Range Button

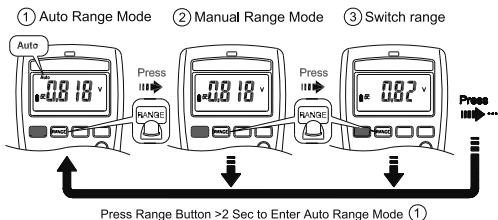

MIN/MAX

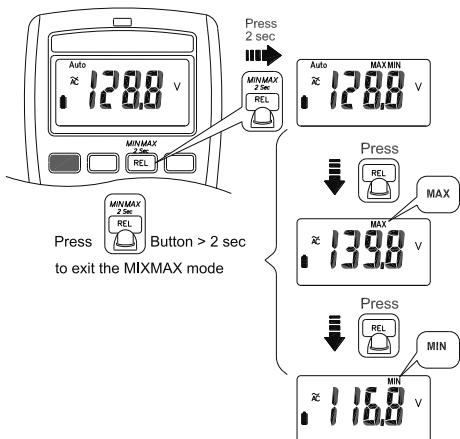

The MAX/MIN mode records the min and max input values. When the input goes below the recorded min value or above the recorded max value, the meter records the new value. Press Hold button to pause the recording.

Smart Hold

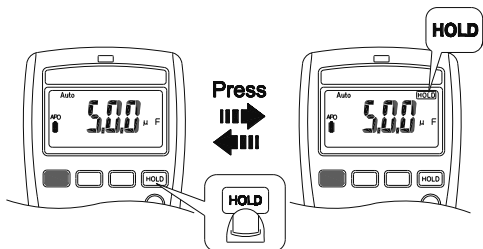

The meter will beep continuously and the display will flash if the measured signal is larger than the display reading by 50 counts. (However, it can not detect across the AC and DC Voltage / Current).

Relative Δ

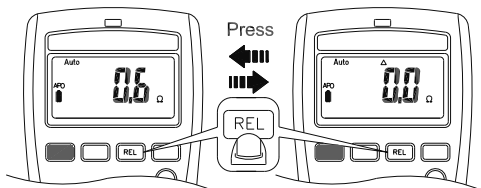

Press the Relative button to enable/disable this function.

Backlight

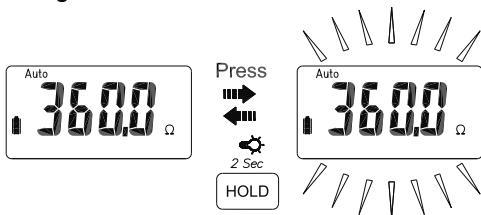

Press the HOLD button over 2 sec to turn on/off Backlight.

Auto Power Off

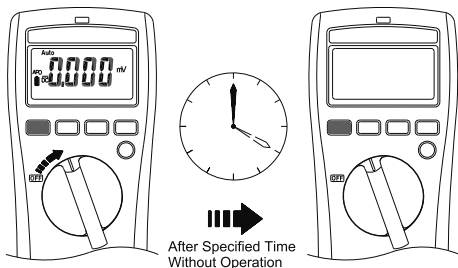

Wake up the meter by dialing the switch or pressing any button.

Time Setting of Auto Power Off

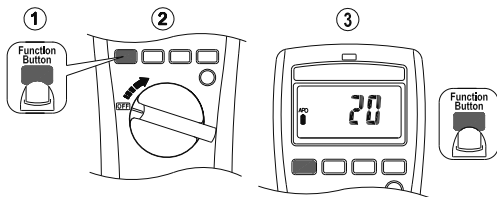

Press the function button and turn the meter on. Then press the function button to select the time. The time can be 5 minutes, 10 minutes, 20 minutes, and disabled (OFF).

High Frequency Rejection (HFR)

The High Frequency Rejection mode equip a low pass filter in the AC measurements. The cut-off frequency (-3dB point) of low pass filter is 800Hz.

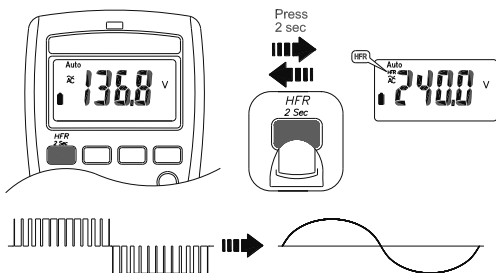

Warning

The hazardous voltage may be present even if the LCD reading is very low in HFR mode. Verify the voltage again without HFR mode.

Testing LCD Monitor

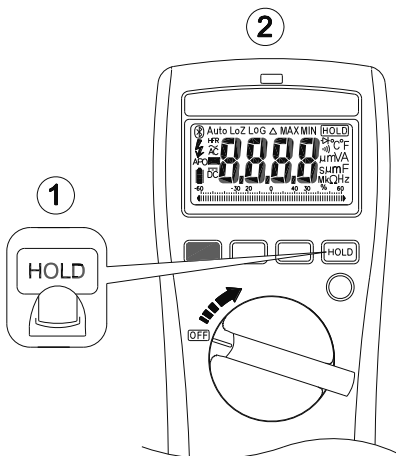

To turn on the meter after keeping HOLD button down.

Function of LOG Button

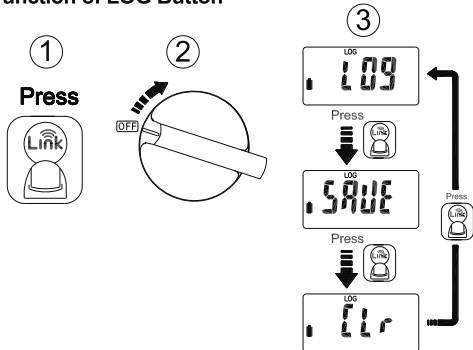

Pressing **Link** button while powering-up to select the mode – Data Logger mode, Manual Saving mode and Clear memory.

Data Logger

The meter can store up to 4000 data in memory.

Press **Link** button for more than 2 seconds to activate Data logger mode. The meter will enter Time interval setting mode. Press **Link** button again to select time interval. The interval can be 1 second, 5 seconds, 10 seconds, 30 seconds, 60 seconds.

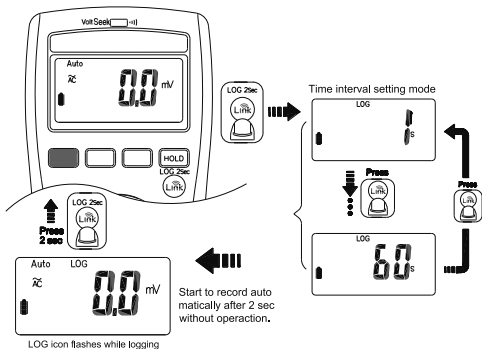

CAUTION

All stored data will be cleared next startup. Download the stored data by App first if needed.

Manual Saving Mode

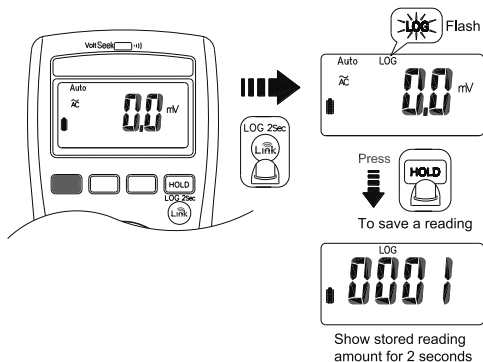

⚠ CAUTION

All stored data are saved until switching to data logger mode or executing the clear function.

Link

The meter uses Bluetooth low energy (BLE) V4.0 wireless technology to transfer the real-time reading and the stored data. The open-air communication range is up to 10m.

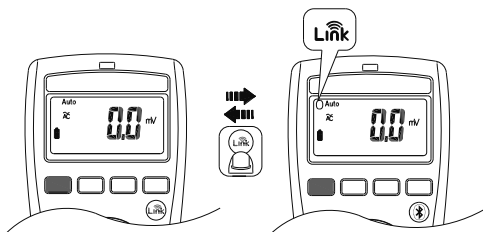

Default Temperature Units Setting

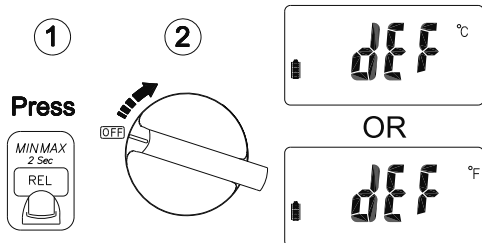

Turn on the meter after keeping the button down.

Fuse Replacement

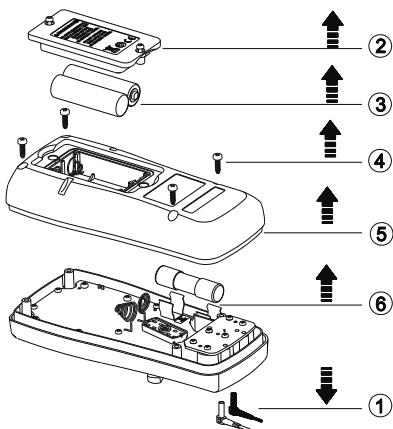

Low Battery and Battery Replacement

Replace the battery as soon as the low battery indicator appears, to avoid false reading.

Refer to the following figure to replace the batteries

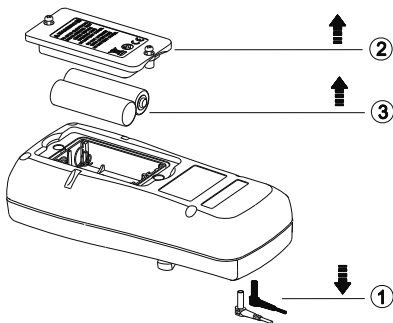

test leads from Meter before opening the battery cover or Meter case.

Specifications

General Specifications

Display : 6000 counts.

Overrange Indication : "OL" or "-OL"

Measure : Samples 3 times per second .

Dimensions (W x H x D) : 74mm x 156mm x 44mm

Weight : 250g (including battery)

Fuse Specification: Fast Action AC/DC 440mA, 1000V, IR 10kA

Batteries Life : 300 hours ALKALINE Battery

Low Batteries Indication :

Voltage drops below operating voltage  will flash.

Power Requirement : AA 1.5V x 2 batteries

Operating Temperature : -10 ~10°C

10°C ~ 30°C (≦80% RH),

30°C ~ 40°C (≦75% RH),

40°C ~ 50°C (≦45%RH)

Storage Temperature :

-20°C to 60°C , 0 to 80% R.H. (batteries not fitted)

Altitude : 6561.7 ft (2000m)

CAT Application field

II	The circuits directly connected to Low-voltage installation.
III	The building installation.
IV	The source of the Low-voltage installation.

Safety : EN 61010-1, EN 61010-2-033 for CAT III 1000V, CAT IV 600V, EN 61326-1

Drop Protection : 4 feet drop to hardwood on concrete floor

Vibration : Random Vibration per MIL-PRF-28800F Class 2

Pollution degree : 2

Indoor Use

Electrical Specifications

Accuracy is given as \pm (% of reading + counts of least significant digit) at $23^{\circ}\text{C} \pm 5^{\circ}\text{C}$, with relative humidity Less than 80% R.H., and is specified for 1 year after calibration.

(1) Temperature coefficient

$0.1 \times (\text{Specified accuracy}) / ^{\circ}\text{C}$, $< 18^{\circ}\text{C}$, $> 28^{\circ}\text{C}$

(2) AC Function

ACV and ACA specifications are ac coupled, true R.M.S.

The crest factor may be up to 3.0 as 4000 counts.

Accuracy is unspecified of Square Wave.

For non-sinusoidal waveforms, Additional Accuracy by Crest Factor (C.F.):

Add 3.0% for C.F. 1.0 ~ 2.0.

Add 5.0% for C.F. 2.0 ~ 2.5.

Add 7.0% for C.F. 2.5 ~ 3.0.

Max. Crest Factor of Input Signal:

3.0 @ 3000 counts

2.0 @ 4500 counts

1.5 @ 6000 counts

Frequency Response is specified for sine waveform.

LCD displays 0 counts when the reading < 20 counts.

(3) DC mV

Range	OL Reading	Resolution	Accuracy
600.0mV	660.0mV	0.1mV	$\pm (0.5\% + 5D)$

Input Impedance : 100M Ω

Overload Protection : AC/DC 1000V

(4) DC Voltage

Range	OL Reading	Resolution	Accuracy
6.000V	6.600V	0.001V	±(0.5% + 2D)
60.00V	66.00V	0.01V	
600.0V	660.0V	0.1V	
1000V	1100V	1V	

Input Impedance : 10MΩ**Overload Protection** : AC/DC 1000V**(5) AC Voltage**

Range	OL Reading	Resolution	Accuracy
600.0mV	660.0mV	0.1mV	±(1.0% + 5D)
6.000V	6.600V	0.001V	±(1.0% + 3D)
60.00V	66.00V	0.01V	
600.0V	660.0V	0.1V	
1000V	1100V	1V	

Input Impedance : 10MΩ // less than 100pF**Frequency Response** : 45 ~ 500Hz (Sine Wave)**Overload Protection** : AC/DC 1000V**(6) AutoV LoZ Voltage**

Range	OL Reading	Resolution	Accuracy
600.0V	660.0V	0.1V	±(2.0% + 3D)
1000V	1100V	1V	

Input Impedance : less than 3kΩ**Frequency Response** : 45 ~ 500Hz (Sine Wave)**Overload Protection** : AC/DC 1000V

(7) DC μ A

Range	OL Reading	Resolution	Accuracy
600.0 μ A	660.0 μ A	0.1 μ A	$\pm(1.0\% + 5D)$
6.000mA	6.600mA	0.001mA	$\pm(1.0\% + 3D)$
60.00mA	66.00mA	0.01mA	
400.0mA	440.0mA	0.1mA	

Overload Protection : Fuse AC/DC 440mA

(8) AC μ A

Range	OL Reading	Resolution	Accuracy
600.0 μ A	660.0 μ A	0.1 μ A	$\pm(1.5\% + 5D)$
6.000mA	6.600mA	0.001mA	$\pm(1.5\% + 3D)$
60.00mA	66.00mA	0.01mA	
400.0mA	440.0mA	0.1mA	

Frequency Response : 45 ~ 500Hz (Sine Wave)

Overload Protection : Fuse AC/DC 440mA

(9) DC Current

Range	OL Reading	Resolution	Accuracy
6.000A	6.600A	0.001A	$\pm(1.0\% + 3D)$
10.00A	20.00A	0.01A	

Maximum measurement time :

>5A for max.3 minutes with at least 20 minutes rest time.

>10A for max.30 seconds with at least 10 minutes rest time.

Overload Protection : Fuse AC/DC 11A

(10) AC Current

Range	OL Reading	Resolution	Accuracy
6.000A	6.600A	0.001A	$\pm(1.5\% + 3D)$
10.00A	20.00A	0.01A	

Maximum measurement time :

>5A for max.3 minutes with at least 20 minutes rest time.

>10A for max.30 seconds with at least 10 minutes rest time.

Frequency Response : 45 ~ 500Hz (Sine Wave)

Overload Protection : Fuse AC/DC 11A

(11) Resistance

Range	OL Reading	Resolution	Accuracy
600.0Ω	660.0Ω	0.1Ω	±(0.9% + 5D)
6.000kΩ	6.600kΩ	0.001kΩ	±(0.9% + 2D)
60.00kΩ	66.00kΩ	0.00kΩ	±(0.9% + 2D)
600.0kΩ	660.0kΩ	0.1kΩ	±(0.9% + 2D)
6.000MΩ	6.600MΩ	0.001MΩ	±(0.9% + 2D)
40.00MΩ*	44.00MΩ	0.01MΩ	±(1.5% + 5D)

* There is a little rolling less than ±50 digits when measuring >10.00 MΩ.

Overload Protection : AC/DC 1000V

(12) Continuity

Range	OL Reading	Resolution	Accuracy
600.0Ω	660.0Ω	0.1Ω	±(0.9% + 5D)

Continuity : Built-in buzzer sounds when measured resistance is less than 20Ω and sounds off when measured resistance is more than 200Ω, Between 20Ω to 200Ω the buzzer maybe sound or off either.

Continuity Indicator : 2.7K Tone Buzzer

Response Time of Buzzer : < 100msec.

Overload Protection : AC/DC 1000V

(13) Diode

Range	OL Reading	Resolution	Accuracy
1.500V	1.550V	0.001V	±(0.9% + 2D)

Open Circuit Voltage : Approx. 1.8V

Overload Protection : AC/DC 1000V.

(14) Capacitance

Range	OL Reading	Resolution	Accuracy
1.000 μ F	1.100 μ F	0.001 μ F	$\pm(1.9\% + 5D)$
10.00 μ F	11.00 μ F	0.01 μ F	$\pm(1.9\% + 2D)$
100.0 μ F	110.0 μ F	0.1 μ F	
1.000mF	1.100mF	0.001mF	
10.00mF	11.00mF	0.01mF	

Overload Protection : AC/DC 1000V

(15) Frequency

Range	OL Reading	Resolution	Accuracy
100.00Hz	100.00Hz	0.01Hz	$\pm(0.1\% + 2D)$
1000.0Hz	1000.0Hz	0.1Hz	
10.000kHz	10.000kHz	0.001kHz	
100.00kHz	100.00kHz	0.01kHz	

Minimum Sensitivity (Voltage) :

Range	Sensitivity
1Hz – 10kHz	>5V
10kHz – 50kHz	>20V
50kHz – 100kHz	unspecified

Minimum Sensitivity (Ampere) : >0.6A

(16) VoltSeek

Voltage Range of High Sensitivity :

80V ~ 1000V (At the top edge of the meter)

Voltage Range of Low Sensitivity :

160V ~ 1000V (At the top edge of the meter)

(17) HFR (High Frequency Rejection)

Available for AC only.

Add $\pm 4\%$ to specified accuracy of each function and each range for 45Hz to 200Hz.

Accuracy is unspecified for $> 200\text{Hz}$.

Cut-off Frequency (-3dB) : 800Hz

(18) Temperature

Range	OL Reading	Resolution	Accuracy
-40.0°C – 400.0°C	440.0°C	0.1°C	$\pm(1\% + 20D)$
-40.0°F – 752.0°F	824.0°F	0.1°F	$\pm(1\% + 36D)$

Accuracy is available with backlight off. The heat of backlight may deviate the measurement. The accuracy does not include the accuracy of the thermocouple probe.

Accuracy specification assumes surrounding temperature stable to $\pm 1^\circ\text{C}$. For surrounding temperature changes of $\pm 2^\circ\text{C}$, rated accuracy applies after 2 hours.

Overload Protection : AC/DC 1000V



CANADA & USA

MGL America, Inc. ✉ cs.na@mgl-intl.com
2810 Coliseum Centre Drive, Ste. 100. Charlotte,
North Carolina 28217 USA
Tel: +1 833 533-5899

MEXICO & LATAM

MGL LATAM S.A DE CV ✉ cs.latam@mgl-intl.com
Colonia Industrial Vallejo Del. Azcapotzalco 02300,
Mexico D.F
Tel: +1 833-533-5899

EMEA

MGL Euman, S.L. ✉ cs.emea@mgl-intl.com
Parque Empresarial Argame, 33163 Morcín.
Asturias, Spain.
Tel: +34 985-08-18-70

UNITED KINGDOM

MGL GROUP U.K. LIMITED ✉ cs.uk@mgl-intl.com
14 Weller St, London, SE1 1QU, UK
Tel: +34 985-08-18-70

www.kps-intl.com

MGL  [®]
Incorporated with MGL

SKU Number:
KPSDMM3500BTCBINT

700019889 JULY 2021 V1

©2021 MGL International Group Limited. All rights reserved.
Specifications are subject to change without notification.