



2022 CATALOGUE

CONTENT INDEX

02	MGL GROUP	
	WHO IS MGL.....	02
	OUR BRANDS.....	02

03	MEASURING INSTRUMENTS	
	NEW PRODUCTS AND TECHNOLOGIES.....	03
	MULTIMETERS.....	06
	CLAMP METERS.....	19
	VOLTAGE TESTERS & TESTERS	26
	ENVIRONMENTAL TESTERS.....	30
	WIRE TESTERS	34
	INDUSTRIAL TESTERS.....	38
	BUNDLES	40
	ACCESSORIES	41

42	ENERGY SAVING	
	MOVEMENT DETECTORS	44
	SENSOR LIGHTS	58
	LIGHT CONTROLS.....	62
	DOOR CHIMES	68
	SECURITY DETECTORS	73
	THERMOSTATS & CHRONOTHERMOSTATS ..	81
	TIMER SWITCHES	86

88	INSTALLATION	
	FISH TAPES	90
	CONNECTORS AND TERMINALS.....	94

WHO IS MGL

We are a global group of companies operating locally. We manufacture test and measurement products for the electrical and automotive industry, from the entry level through high tech products.

Our companies work globally, serving our customers worldwide. This global network delivers a deeper understanding of each individual market, with solutions tailored to the unique requirements of each customer.

With customers over 20 years old, our goal is to be a recognized, honest and fair company. We aim to be the most valued partner for our customers in the research, development, manufacture and supply of innovative, modern and customer-focused technologies.

We have a highly experienced team which is openminded, receptive to new ideas and adaptive to evolving market trends. This solid foundation guarantees that we are well informed and fully equipped to deliver excellent solutions to meet our customers' real needs.



OUR BRANDS

We manufacture electrical test and measurement instruments under our own brands: Mastech, KPS, C-Logic and Power Probe, recognized brands and market leaders in the fields of electrical measurement and automotive. All of our products have a professional positioning based on advanced balanced technology and they are marketed through local distributors throughout the world.

We maintain direct and close contact with our distributors, through our offices around the world, and we support them in their business by offering technical advice and an after-sales service for our products.

MGL AT A GLANCE



More than 800 employees



Annual production of +10 million units per year



Three factories in Taiwan, China and Europe



We manufacture more than 95% of our products, even the accessories

NEW PRODUCTS AND TECHNOLOGIES

Digital multimeter



C-LOGIC 545

- Digital multimeter that has the ability to measure different electrical parameters : AC / DC voltage, DC current, resistance. Incorporates Non Contact Voltage detection

Further information on page 10

Digital multimeter



C-LOGIC 560

- Auto- ranging digital multimeter that has the ability to measure different electrical parameters: AC / DC voltage, AC/DC current, resistance and Temperature. Incorporates Non Contact Voltage detection

Further information on page 11

Digital clamp meter



C-LOGIC 840

- True RMS digital clamp meter with capability for measurements on AC/DC Voltage, AC current, and Resistance

Further information on page 24



MEASURING INSTRUMENTS

- MULTIMETERS
- CLAMP METERS
- VOLTAGE TESTERS
- ENVIRONMENTAL TESTERS
- WIRE TESTERS
- INDUSTRIAL TESTERS
- BUNDLES

SYMBOL	DESCRIPTION
	CONTENTS
	Instructions
	1.5V AAA battery
	9V 6F22 battery
	12V A23S battery
	Test probes
	Test probes
	K-type thermocouple
	Multifunction socket
	Carrying bag
	Alligator clips
	RS232 connection (Serial port)
	Hard case
	USB charger
	CD box
	Earth rod
	Reflective sheet
	Earth probes
	Alligator clips & cables
	MAIN APPLICATIONS
	AC voltage measuring
	DC voltage measuring
	AC current measuring
	DC current measuring
	AC current measuring
	DC current measuring
	Resistance measuring

SYMBOL	DESCRIPTION
	Capacitance
	Continuity measuring
	Diode test
	Frequency measuring
	Temperature measuring
	hFE transistor
	Duty Cycle measuring
	Metal detection
	Lux level measuring
	Sound level measuring
	Revolutions per minute measuring
	Insulation test
	Power measuring
	FEATURES
	Auto power off
	Auto range
	Diode test
	Continuity test
	Max & min values
	Non-Contact voltage
	Low Impedance
	True root mean square
	Smartphone connectivity
	Transistor
	Back light display
	Data hold
	Work light

SYMBOL	DESCRIPTION
	Inrush current
	Data log
	Light indicator
	Acoustic indicator
	Metal detection
	RCD
	Luxes measurement
	Candel measurement
	Foot-Candel measurement
	Valid for LED light measuring
	Laser
	USB connection
	Over & under range alert
	AC weighting
	Average
	Timer
	Memory
	Dielectric absorption ratio / Polarization index
	Relative measurement
	Low battery display
	PC connection
	Emissivity
	Noise frequency weighting
	Valid for telephone cable line testing
	Valid for Ethernet cable testing
	Valid for TV/coaxial cable testing
	Broken cable testing



- Pocket format that facilitates product portability.
- Test leads integrated which facilitates the use and the storage.



More info

C-LOGIC 55

Digital multimeter
 SKU No : CLOGIC55CBINT
 EAN Code : 8435394775487
 UPC Code : 810053670996

CONTENTS



MAIN APPLICATIONS



DOMESTIC

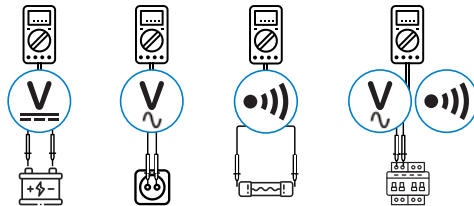

ELECTRONICS

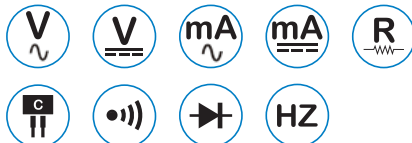
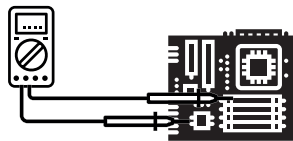

SPECIFICATIONS

AC VOLTAGE

300V

DC VOLTAGE

300V

AC CURRENT

200mA

RESISTANCE

2MΩ

DISPLAY COUNTS

2000



FEATURES

Display counts	2000
Diode	Open Voltage 3.0V
Continuity Buzzer	< 50±20Ω •
LBD	Low Battery Display •

GENERAL

Power Supply	1×12V A23S Battery included
Product Size	120mmx70mmx18mm/4.7"x2.75"x0.7"
Product Weight	110g/0.23lb
Certificate	RoHs, CE, ETL
Safety Rating	CAT II 600V, CAT III 300V

PACKAGING & LOGISTICS INFORMATION

HS Code: 90303200

Carton box

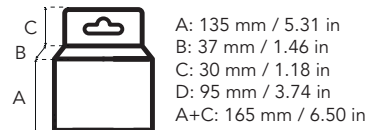

A: 135 mm / 5.31 in
 B: 37 mm / 1.46 in
 C: 30 mm / 1.18 in
 D: 95 mm / 3.74 in
 A+C: 165 mm / 6.50 in



Export carton

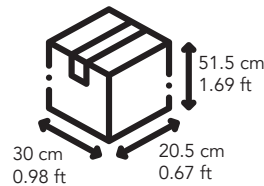

30 cm / 0.98 ft
 20.5 cm / 0.67 ft
 51.5 cm / 1.69 ft

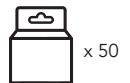

Pallet

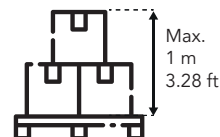

Max.
 1 m / 3.28 ft

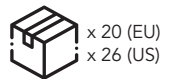

+ 15 kg / 33.06 lb from pallet



- Rubber housing for better comfort in use.
- Hinged bracket to facilitate table work.
- Resistance, diode, continuity and data hold.



C-LOGIC 520

Digital multimeter
 SKU No : CLOGIC520CBINT
 EAN Code : 8435394775494
 UPC Code : 810053670965



More info

SPECIFICATIONS

AC VOLTAGE 600V	DC VOLTAGE 600V	DC CURRENT 10A
RESISTANCE 2MΩ	DISPLAY COUNTS 2000	



FEATURES

Display counts	2000
Diode	Open Voltage 3.0V
Continuity Buzzer	<50Ω
Data Hold	•
LBD	Low Battery Display •
Battery Test	1.5V/9V/12V •

GENERAL

Power Supply	1x9V6F22 NEDA 1604 Battery included
Product Size	148mmx73.5mmx50mm/5.8" x2.9"x1.96"
Product Weight	232g/0.51lb
Certificate	RoHs, CE, ETL
Safety Rating	CAT III 600V

PACKAGING & LOGISTICS INFORMATION

HS Code: 90303200

Check available packaging options.

CONTENTS



MAIN APPLICATIONS

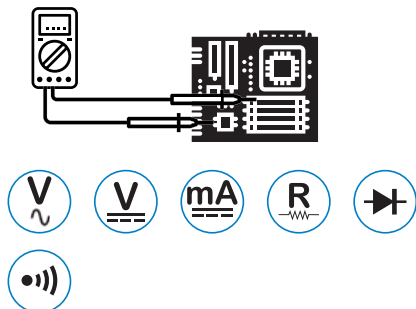
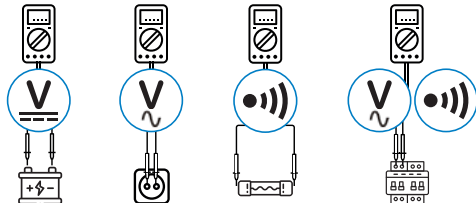



NEW

- Display 2000 counts
- Manual ranging
- AC/DC Voltage (600V)
- DC Current (10A)
- Resistance (2MΩ)
- Diode and continuity tests
- Non Contact Voltage Detection
- With battery test function
- Data hold



C-LOGIC 545

Digital multimeter
 SKU No : CLOGIC545CBINT
 EAN Code: 8435394788043
 UPC Code: 810053678411

CONTENTS

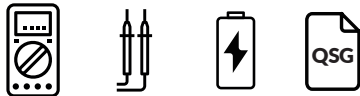

MAIN APPLICATIONS



DOMESTIC

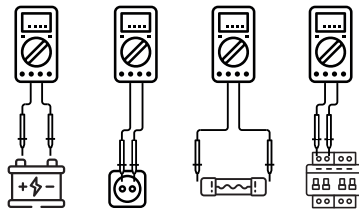

ELECTRONICS

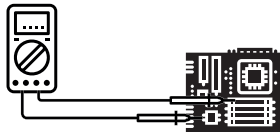

SPECIFICATIONS

AC VOLTAGE 600V	DC VOLTAGE 600V	DC CURRENT 10A
RESISTANCE 2MΩ	CONTINUITY <60Ω	DISPLAY COUNTS 2000



FEATURES

Display counts	2000
Manual Ranging	•
Diode	Open Voltage 3.0V
Continuity Buzzer	<60Ω
Display Backlight	•
Data Hold	•
NCV	Non-Contact Voltage Detector •

GENERAL

Power Supply	1x9V 6F22 Battery
Product Size	140mm x 67mm x 30mm/5.5" x 2.6" x 1.2"
Product Weight	112g / 0.25lb
Certificate	RoHs, CE, UKCA
Safety Rating	CAT III 600V

PACKAGING & LOGISTICS INFORMATION

HS Code: 90303200

Carton box

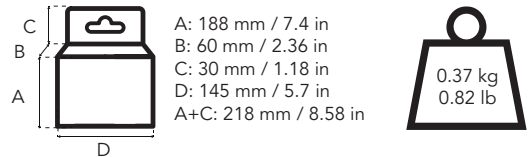

Export carton

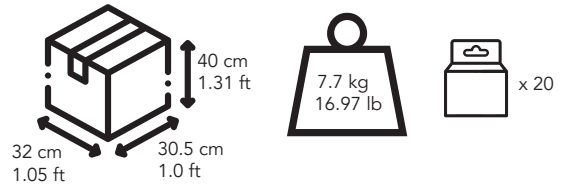

Pallet

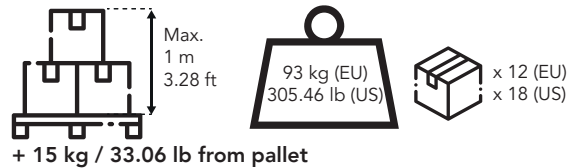



NEW

- Display 2000 counts
- Auto & Manual ranging
- AC/DC voltage (600V)
- AC/DC current (10A)
- Resistance (20MOhms)
- Temperature
- Diode and continuity test
- Non Contact Voltage Detection
- Auto Power Off
- Data hold



C-LOGIC 560

Digital multimeter
 SKU No : CLOGIC560CBINT
 EAN Code: 8435394788050
 UPC Code: 810053678404

CONTENTS

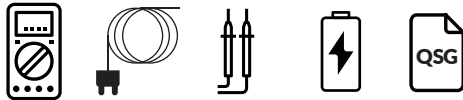

MAIN APPLICATIONS

DOMESTIC

INDUSTRIAL

ELECTRONICS

SPECIFICATIONS

AC VOLTAGE 600V	DC VOLTAGE 600V	DC CURRENT 10A
RESISTANCE 20MΩ	CONTINUITY <70Ω	TEMPERATURE -20~1000°C -4~1832°F

DISPLAY COUNTS
2000



FEATURES

Display counts	2000
Auto Ranging	•
Auto Power Off	•
Diode	Open Voltage 1.5V
Continuity Buzzer	<70Ω
Display Backlight	•
Data Hold	•
NCV	Non-Contact Voltage Detector •

GENERAL

Power Supply	1x9V 6F22 Battery
Product Size	140mm x 67mm x 30mm/5.5" x 2.6" x 1.2"
Product Weight	112g / 0.25lb
Certificate	RoHs, CE, UKCA
Safety Rating	CAT III 600V

PACKAGING & LOGISTICS INFORMATION

HS Code: 90303200

Carton box

A: 188 mm / 7.4 in
 B: 60 mm / 2.36 in
 C: 30 mm / 1.18 in
 D: 145 mm / 5.7 in
 A+C: 218 mm / 8.58 in
 Weight: 0.38 kg / 0.84 lb

Export carton

Dimensions: 40 cm / 1.31 ft (height), 32 cm / 1.05 ft (width), 30.5 cm / 1.0 ft (depth)
 Weight: 7.7 kg / 16.97 lb
 Quantity: x 20

Pallet

Max. height: 1 m / 3.28 ft
 Weight: 93 kg (EU) / 305.46 lb (US)
 Quantity: x 12 (EU) / x 18 (US)
 + 15 kg / 33.06 lb from pallet



- Rubber housing for better comfort in use.
- Hinged bracket to facilitate table work.
- AC /DC current ,AC/DC Voltage, capacitance, frequency, temperature and transistor.



More info

C-LOGIC 5100

Digital multimeter
 SKU No : CLOGIC5100CBINT
 EAN Code : 8435394775562
 UPC Code : 810053670941

CONTENTS

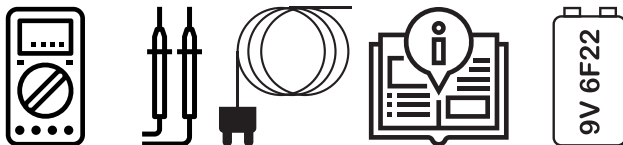

MAIN APPLICATIONS

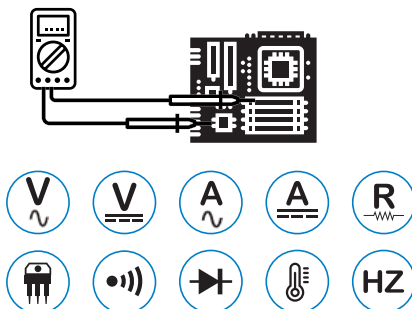
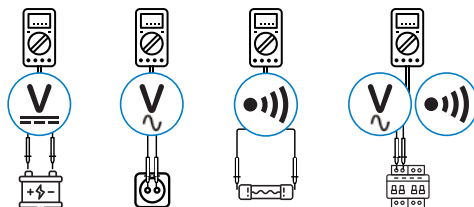

SPECIFICATIONS

AC VOLTAGE 600V	DC VOLTAGE 600V	AC CURRENT 10A
DC CURRENT 10A	RESISTANCE 200MΩ	CAPACITANCE 100μF
FREQUENCY 20kHz	TEMPERATURE -20°C~1000°C 1°F~1832°C	DISPLAY COUNTS 2000



FEATURES

Display counts	2000
APO	Auto Power OFF
Transistor hFE	0~1000
Diode	Open Voltage 3.0V
Continuity Buzzer	<50Ω
Data Hold	
LBD	Low Battery Display

GENERAL

Power Supply	1x9V 6F22 Battery included
Product Size	188mm x 93mm x 50mm/7.4" x 3.7" x 1.96"
Product Weight	380g/0.84lb
Certificate	RoHs, CE, ETL
Safety Rating	CAT III 600V

PACKAGING & LOGISTICS INFORMATION

HS Code: 90303200

Carton box

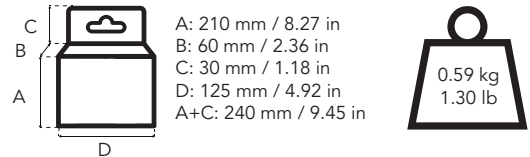

Export carton

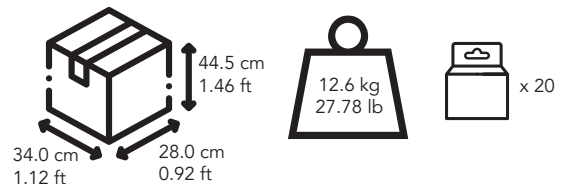

Pallet

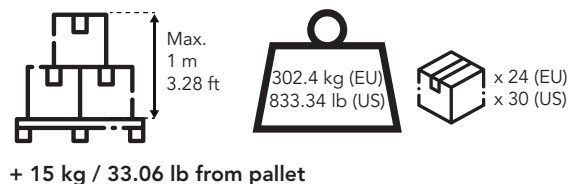



- Rubber housing for better comfort in use.
- Hinged bracket to facilitate table work.
- Professional reference. Industrial multimeter.



PRO



More info

C-LOGIC 5200

Digital multimeter
 SKU No : CLOGIC5200CBINT
 EAN Code : 8435394775593
 UPC Code : 810053671498

CONTENTS

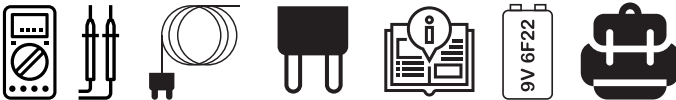

MAIN APPLICATIONS

DOMESTIC

ELECTRONICS

INDUSTRIAL

SPECIFICATIONS

AC VOLTAGE 1000V	DC VOLTAGE 1000V	AC CURRENT 10A
DC CURRENT 10A	RESISTANCE 66MΩ	CAPACITANCE 66mF
FREQUENCY 10kHz/66MHz	TEMPERATURE 0°C~1000°C 32°F~1832°F	DUTY CYCLE 1%~99.9%

DISPLAY COUNTS
6600

Apo

MAX
MIN

NCV

AUTO

H

FEATURES

Display counts	6600
Auto Ranging	•
Manual Ranging	•
APO	Auto Power OFF
REL	Relative Measurement
NCV	Non-Contact Voltage Detector
Diode	Open Voltage
Continuity Buzzer	<50Ω
MAX/MIN	•
Data Hold	•
LBD	Low Battery Display
Display Backlight	•

GENERAL

Power Supply	1x9V 6F22 Battery included
Product Size	175mm x 85mm x 52mm/6.9" x 3.3" x 2.1"
Product Weight	420g/0.92lb
Certificate	RoHs, CE, ETL
Safety Rating	CAT III 1000V / CAT IV 600V

PACKAGING & LOGISTICS INFORMATION

HS Code: 90303200

Carton box

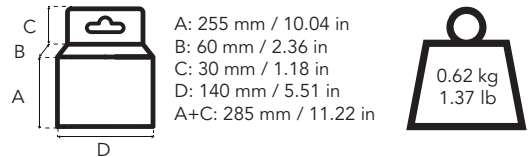

Export carton

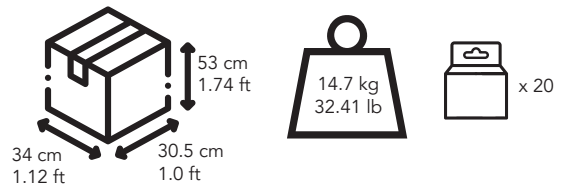

Pallet





- Industrial range multimeter up to 1000V
- TRMS
- Cat. IV 600V



PRO



More info

C-LOGIC 5600

Digital multimeter
 SKU No : CLOGIC5600CBINT
 EAN Code : 8435394775654
 UPC Code : 810053671559

SPECIFICATIONS

AC VOLTAGE 1000V	DC VOLTAGE 1000V	AC CURRENT 10A
DC CURRENT 10A	RESISTANCE 66MΩ	CAPACITANCE 66mF
FREQUENCY 10kHz/66MHz	TEMPERATURE 0°C~1000°C 32°F~1832°F	DUTY CYCLE 1%~99.9%

DISPLAY COUNTS: 6600

Buttons: Apo, Lo-Z, TRMS, MAX MIN, NCV, AUTO, H, REL

FEATURES

Display counts	6600
Auto Ranging	•
Manual Ranging	•
REL	Relative Measurement
NCV	Non-Contact Voltage Detector
Diode	Open Voltage
Continuity Buzzer	<50Ω
Data Hold	•
LBD	Low Battery Display
Display Backlight	•
True RMS	True Root Mean Square
Low Z	Low Impedance Input Mode

GENERAL

Power Supply	1x9V 6F22 Battery included
Product Size	175mm x 85mm x 52mm/6.9" x 3.3" x 2.1"
Product Weight	420g/0.92lb
Certificate	RoHs, CE, ETL
Safety Rating	CAT III 1000V / CAT IV 600V

PACKAGING & LOGISTICS INFORMATION

HS Code: 90303200

Carton box

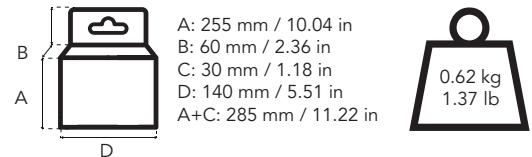

Export carton

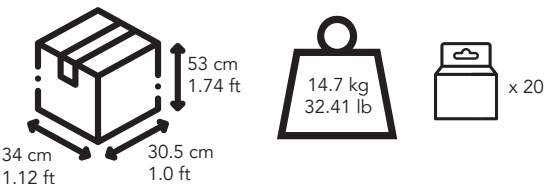

Pallet



CONTENTS

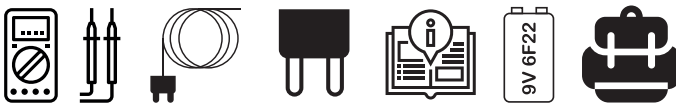

MAIN APPLICATIONS

DOMESTIC

ELECTRONICS

INDUSTRIAL



- Rubber housing for better comfort in use.
- Hinged bracket to facilitate table work
- Auto-range, relative, humidity, luminosity and sound level.
- Professional reference.

CAT III
600V



PRO



More info

C-LOGIC 5300

Digital multimeter
SKU No : CLOGIC5300CBINT
EAN Code : 8435394775609
UPC Code : 810053671504

CONTENTS



MAIN APPLICATIONS

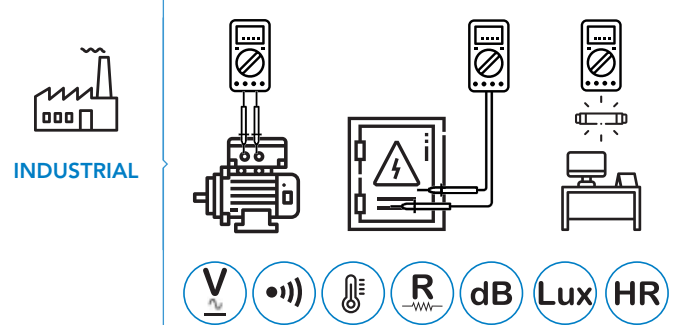
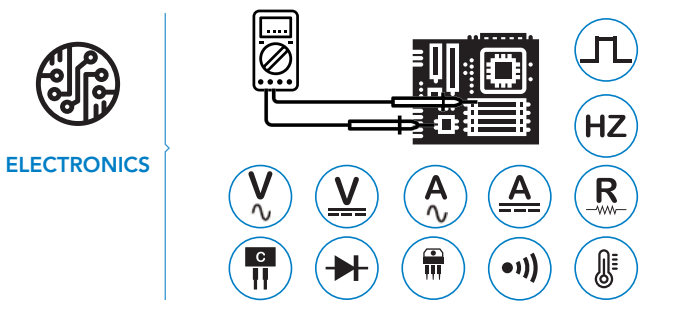
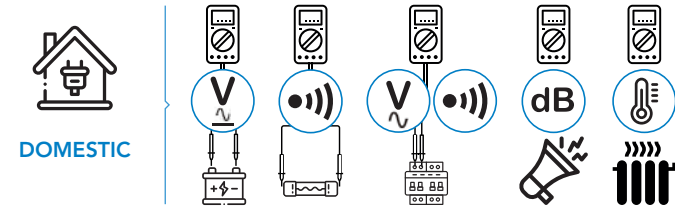

SPECIFICATIONS

AC VOLTAGE 600V	DC VOLTAGE 600V	AC CURRENT 10A
DC CURRENT 10A	RESISTANCE 40MΩ	CAPACITANCE 100μF
FREQUENCY >200kHz	DUTY CYCLE 0.1%~99.9%	SOUND LEVEL 40dB~100dB
LUMINOSITY 4000~40000Lux	REL. HUMIDITY 20%~95%	
TEMPERATURE -20°C~1000°C -4°F~1832°F	ENVIRONMENT 0°C~40°C 32°F~104°F	DISPLAY COUNTS 4000



FEATURES

Display counts	4000
Auto Ranging	•
Manual Ranging	•
APO	Auto Power OFF
°C/°F Selection	•
Diode	Open Voltage
Continuity Buzzer	<50Ω±20Ω
Data Hold	•
LBD	Low Battery Display
Display Backlight	•
Sound & Light Warning	For Incorrect insertion of the input plugs (S version only)

GENERAL

Power Supply	3x1.5V AAA Battery included
Product Size	195mm x 92mm x 55mm/7.7" x 3.6" x 2.2"
Product Weight	390g/0.86lb
Certificate	RoHs, CE, ETL
Safety Rating	CAT III 600V

PACKAGING & LOGISTICS INFORMATION

HS Code: 90303200

Carton box

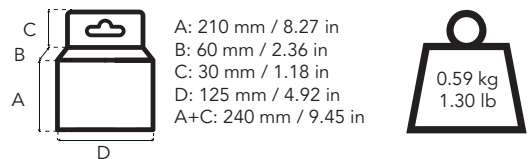

Export carton

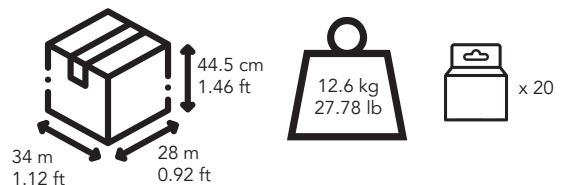

Pallet

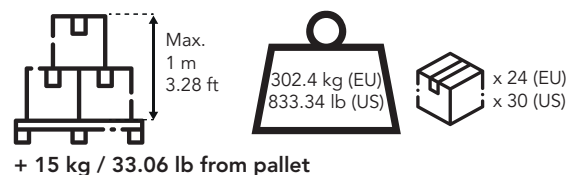



- Smartphone connectivity
- APP allows readings on real time & records
- Rubber housing for better confort in use.
- Hinged bracket to facilitate table work.



C-LOGIC 5900

Digital multimeter Smartphone connectivity
 SKU No : CLOGIC5900CBINT
 EAN Code : 8435394775517
 UPC Code : 810053671399



More info

SPECIFICATIONS

AC VOLTAGE 600V	DC VOLTAGE 600V	AC CURRENT 10A
DC CURRENT 10A	RESISTANCE 40MΩ	CAPACITANCE 99.99mF
FREQUENCY (A) >10kHz	FREQUENCY (V) >1kHz	DUTY CYCLE 0.1%-99.9%



FEATURES

Display counts		4000
Auto Ranging		•
Manual Ranging		•
APO	Auto Power OFF	•
True RMS	For AC Voltage & AC Current	•
Diode	Open Voltage	3.2V
Continuity Buzzer	<50Ω	•
Data Hold		•
LBD	Low Battery Display	•
NCV	Non-Contact Voltage Detector	•
Battery Tester	1.5V/9V	•
Wireless	APP connection	•

GENERAL

Power Supply	1×9V 6F22 Battery included
Product Size	188mm×92mm×50mm / 7.4"×3.6"×2.0"
Product Weight	380g/0.83lb
Certificate	RoHs, CE, ETL
Safety Rating	CAT III 600V

PACKAGING & LOGISTICS INFORMATION

HS Code: 90303200

Carton box

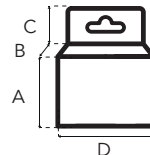

A: 210 mm / 8.27 in
 B: 60 mm / 2.36 in
 C: 30 mm / 1.18 in
 D: 125 mm / 4.92 in
 A+C: 240 mm / 9.45 in



Export carton

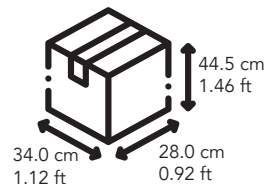

34.0 cm / 1.12 ft
 44.5 cm / 1.46 ft
 28.0 cm / 0.92 ft



Pallet

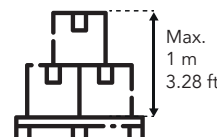

Max. 1 m / 3.28 ft

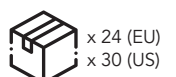
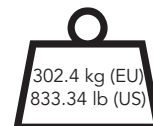

+ 15 kg / 33.06 lb from pallet

CONTENTS

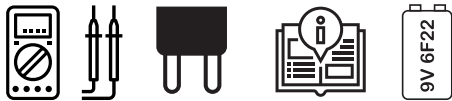

MAIN APPLICATIONS

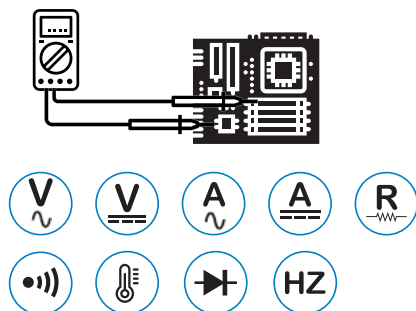
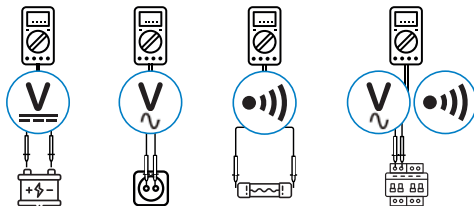



- Smart technology: auto recognition of measurement parameters.
- Avoid error in amateur users.
- Save time in pro users.



C-LOGIC 580

Digital multimeter
 SKU No : CLOGIC580CBINT
 EAN Code : 8435394775500
 UPC Code : 810053671603

CONTENTS



MAIN APPLICATIONS

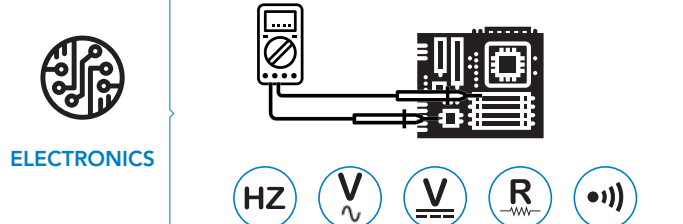
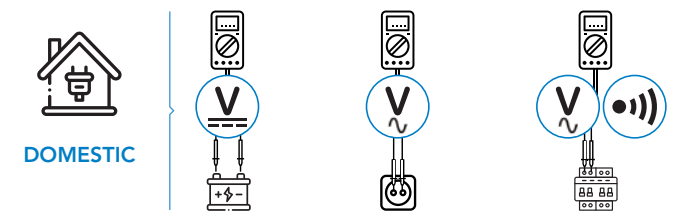

SPECIFICATIONS

AC VOLTAGE 600V	DC VOLTAGE 600V	RESISTANCE 10MΩ
FREQUENCY 3kHz	DUTY CYCLE 10%~90%	SMART
DISPLAY COUNTS 6000	NCV Apo MAX MIN H	

MAIN FEATURES

FEATURES	
Display counts	6000
Auto range	Auto
APO	Auto Power Off
Dual Display	
Continuity Buzzer	<40Ω
Data hold	
MAX/MIN	
Display Backlight	
LBD	Low Battery Display
NCV	Non-Contact Voltage Detector

GENERAL

Power Supply	2×1.5V AAA Batteries included
Product Size	150mm×74mm×48mm/5.9"×2.9"×1.7"
Product Weight	220g/0.48lb
Certificate	RoHs, CE, ETL
Safety Rating	CAT III 600V

PACKAGING & LOGISTICS INFORMATION

HS Code: 90303200

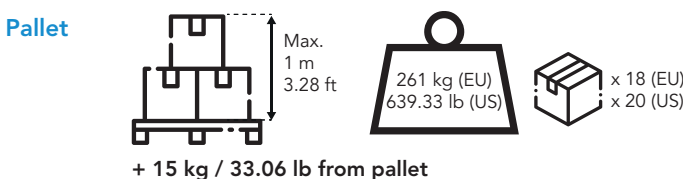
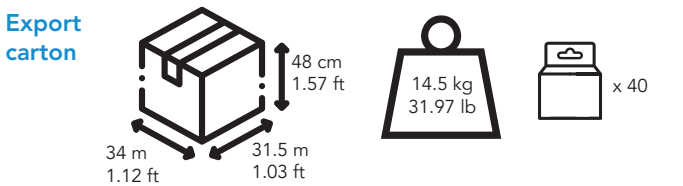
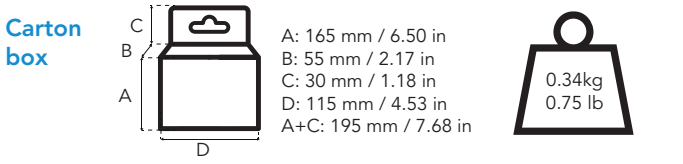



- Rubber housing for better confort in use.
- Pen type.



SPECIFICATIONS

AC VOLTAGE
600V

DC VOLTAGE
600V

AC CURRENT
200mA

DC CURRENT
200mA

RESISTANCE
20MΩ

DISPLAY COUNTS

2000

MAX



Apo

AUTO

H



NCV

FEATURES

Display counts		2000
Auto Ranging	Auto	•
APO	Auto Power OFF	•
NCV	Non-Contact AC Voltage Detector Detection: >50V AC	•
Zero	Zero Adjustment	•
Logic Level test	0~1.5V (Green LED On)	•
	1.5~3.5V (Green & Red LED On)	
	3.5~5V (Red LED On)	
Diode	Open Voltage	1.5V
Continuity Buzzer	<50Ω	•
MAX	Maximum Value Hold	•
Data Hold		•
LBD	Low Battery Display	•
Housing	Double Molding	•

GENERAL

Power Supply	2×1.5V AAA Batteries included
Product Size	238mm×43mm×29mm/9.37"×1.7"×1.1"
Product Weight	112g/0.28lb
Certificate	RoHs, CE, ETL
Safety Rating	CAT III 600V

PACKAGING & LOGISTICS INFORMATION

HS Code: 90303200

Carton box

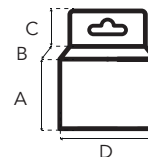

A: 235 mm / 9.25 in
B: 45 mm / 1.77 in
C: 30 mm / 1.18 in
D: 85 mm / 3.35 in
A+C: 265 mm / 10.43 in



Export carton

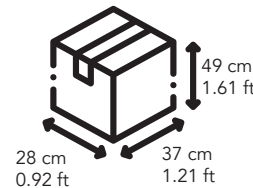

Pallet

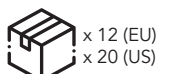
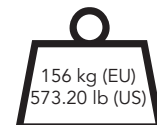
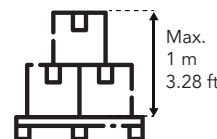

+ 15 kg / 33.06 lb from pallet

C-LOGIC 3200

Pen-type digital multimeter
SKU No : CLOGIC3200CBINT
EAN Code : 8435394775630
UPC Code : 810053670798



More info

CONTENTS



MAIN APPLICATIONS

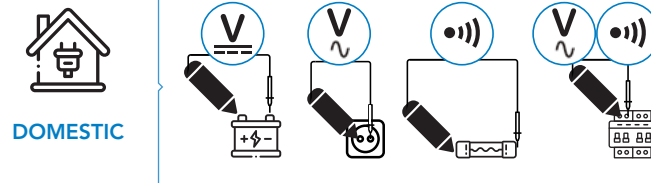



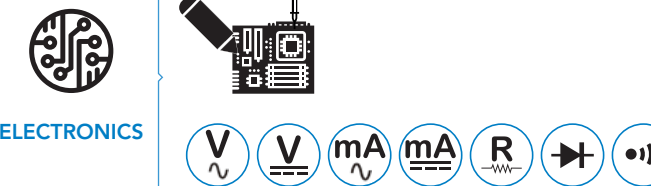

DOMESTIC



ELECTRONICS

FUNCTIONS						
	C-LOGIC 55	C-LOGIC 520	C-LOGIC 545	C-LOGIC 560	C-LOGIC 5100	C-LOGIC 5200
SKU NO.	CLOGIC55CBINT	CLOGIC520CBINT	CLOGIC545CBINT	CLOGIC560CBINT	CLOGIC5100CBINT	CLOGIC5200CBINT
True RMS measurement	-	-	-	-	-	√
Alternating voltage, up to	600V	600V	600V	600V	600V	1000V
Direct voltage, up to	600V	600V	600V	600V	600V	1000V
Alternating current, up to	400mA	-	-	10A	10A	10A
Direct current, up to	400mA	10A	10A	10A	10A	10A
Counts	2000	2000	2000	2000	2000	6600
Resistance, up to	60MΩ	2MΩ	2MΩ	20MΩ	200MΩ	66MΩ
Frequency, up to	100kHz	-	-	-	20kHz	66Hz
Temperature, up to	-	1000°C	1000°C	1000°C	1000°C	1000°C
Capacitance, up to	100μF	-	-	-	100μF	66μF
Continuity buzzer	√	√	√	√	√	√
Transistors test	-	-	-	-	-	-
Diode test	√	√	√	√	√	-
Battery test	-	√	-	-	-	-
DWELL & TACH tests	-	-	-	-	-	-
Network cable check	-	-	-	-	-	-
Phone and tone check	-	-	-	-	-	-
Environmental measurements (RH, temperature, Sound, Luminosity)	-	-	-	-	-	-
Insulation measurement	-	-	-	-	-	-
Non-contact voltage detection	-	-	√	√	-	√
Low input impedance measurements	-	-	-	-	-	-
Data hold	√	√	√	√	√	√
Relative measurements	-	-	-	-	-	√
MAX/MIN values	-	-	-	MAX	-	√
Autoranging	√	-	-	√	√	√
Auto off	√	-	-	√	√	√
Backlight display	-	-	√	√	√	√
Low battery display	√	√	√	√	√	√
Connectivity	-	-	-	-	-	-
Data logging	-	-	-	-	-	-
Category according to EN61010	CAT III 300V CAT II 600V	CAT III 600V	CAT III 600V	CAT III 600V	CAT III 600V	CAT III 1000V CAT IV 600V

FUNCTIONS					
	C-LOGIC 5600	C-LOGIC 5300	C-LOGIC 5900	C-LOGIC 580	C-LOGIC 3200
SKU NO.	CLOGIC5600CBINT	CLOGIC5300CBINT	CLOGIC5900CBINT	CLOGIC580CBINT	CLOGIC3200CBINT
True RMS measurement	√	-	√	-	-
Altern voltage, up to	1000V	600V	600V	600V	600V
Direct voltage, up to	1000V	600V	600V	600V	600V
Altern current, up to	10A	10A	10A	-	200mA
Direct current, up to	10A	10A	10A	-	200mA
Counts	6600	4000	4000	6000	2000
Resistance, up to	-	-	40MΩ	10MΩ	20MΩ
Frequency, up to	66MHz	200kHz	10MHz	3kHz	-
Temperature, up to	1000°C	1000°C	-	-	-
Capacitance, up to	66mF	100 μF	100mF	-	-
Continuity buzzer	√	√	√	√	√
Transistors test	-	-	√	-	-
Diode test	√	√	√	-	√
Battery test	-	-	-	-	-
DWELL & TACH tests	-	-	-	-	-
Network cable check	-	-	-	-	-
Phone and tone check	-	-	-	-	-
Environmental measurements (RH, temperature, Sound, Luminosity)	-	√	-	-	-
Insulation measurement	-	-	-	-	-
Non-contact voltage detection	√	-	√	√	√
Low input impedance measurements	√	-	-	-	-
Data hold	√	√	√	√	√
Relative measurements	√	-	√	-	-
MAX/MIN values	√	-	-	√	MAX
Autoranging	√	√	√	√	√
Auto off	√	√	√	√	√
Backlight display	√	√	√	√	-
Low battery display	√	√	√	√	√
Connectivity	-	-	Bluetooth	-	-
Data logging	-	-	-	-	-
Category according to EN61010	CAT IV 600V CAT III 1000V	CAT IV 600V CAT III 1000V	CAT III 600V	CAT III 600V	CAT III 600V



- VDC 1000V/VAC 750. Resistance, frequency, AC 1000, insulation test.
- Jaw size: 50mm.



C-LOGIC 80

AC Clamp meter 100A
 SKU No : CLOGIC80CBINT
 EAN Code : 8435394776712
 UPC Code : 810053671184



More info

SPECIFICATIONS

AC VOLTAGE

750V

DC VOLTAGE

1000V

AC CURRENT

1000A

RESISTANCE

20kΩ

INSULATION TEST

2000MΩ

DISPLAY COUNTS

2000

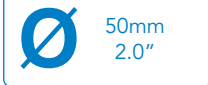

FEATURES

Display counts	2000
Jaw opening Ø	50mm / 2.0"
Continuity Buzzer	<100Ω •
Data Hold	•
LBD	Low Battery Display •

GENERAL

Power Supply	1×9V 6F22 Battery included
Product Size	235mm×96mm×46mm / 9.25"×3.8"×1.8"
Product Weight	268g/0.59lb
Certificate	RoHs, CE, ETL
Safety Rating	CAT II 1000V, CAT III 600V

PACKAGING & LOGISTICS INFORMATION

HS Code: 90303200

Carton box

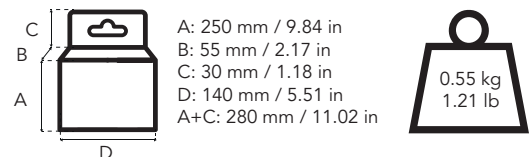

Export carton

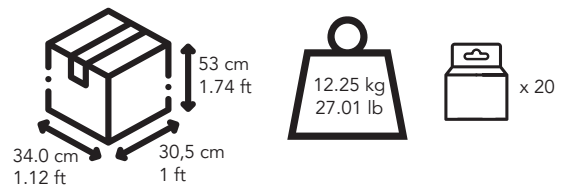

Pallet



CONTENTS



MAIN APPLICATIONS

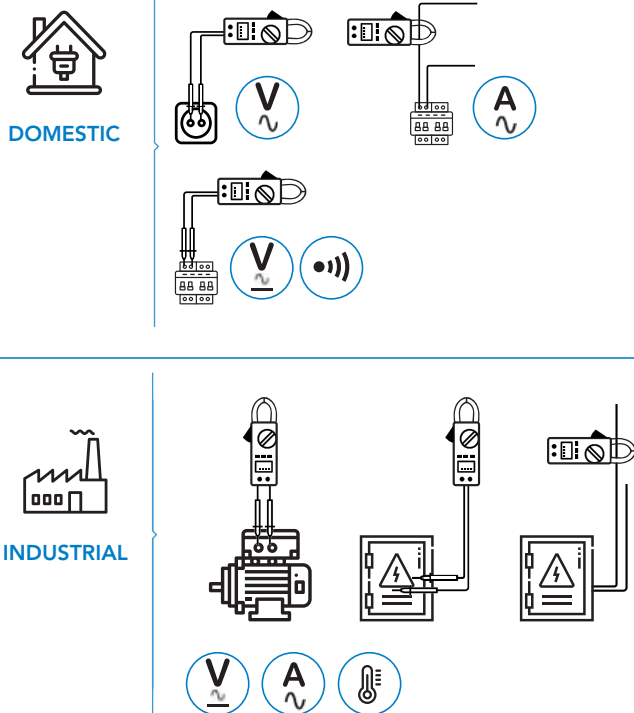



- Small size which facilitates its use and transport
- Jaw size 28mm.



C-LOGIC 85

AC Clamp meter small jaw
 SKU No : CLOGIC85CBINT
 EAN Code : 8435394775524
 UPC Code : 810053671160



More info

SPECIFICATIONS

AC VOLTAGE 600V	DC VOLTAGE 600V	AC CURRENT 400A
RESISTANCE 2kΩ	DISPLAY COUNTS 2000	Ø 28mm 1.1"



FEATURES

Display counts	2000
Jaw Opening	Ø28mm/1.1'
Diode	Open Voltage 4.5V
Continuity Buzzer	<70Ω
Data hold	•
LBD	Low Battery Display

GENERAL

Power Supply	3×1.5V AAA Batteries included
Product Size	198mm×79mm×38mm/7.8"×3.1"×1.5"
Product Weight	195g/0.43lb
Certificate	RoHs, CE, ETL
Safety Rating	CAT III 600V

PACKAGING & LOGISTICS INFORMATION

HS Code: 90303200

Carton box

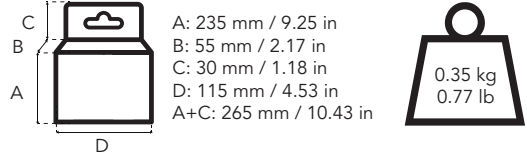

Export carton

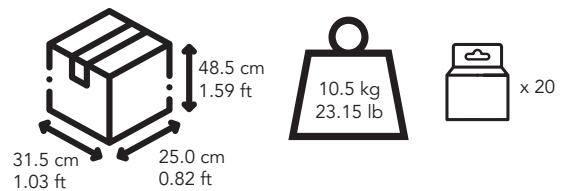

Pallet

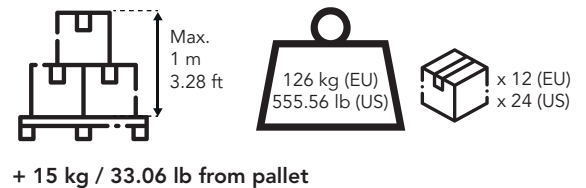

CONTENTS



MAIN APPLICATIONS

DOMESTIC

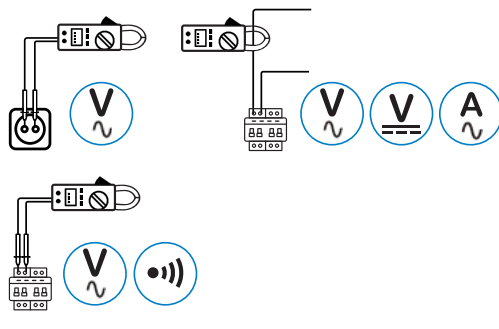

INDUSTRIAL

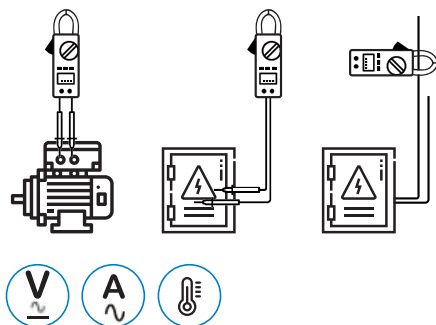



- Double injection housing, which facilitates the grip and handling of the clamp.
- Temperature.
- Work light, Non Contact Voltage (NCV).



C-LOGIC 810

AC clamp meter 600A
 SKU No : CLOGIC810CBINT
 EAN Code : 8435394775616
 UPC Code : 810053671191



More info

SPECIFICATIONS

AC VOLTAGE 600V	DC VOLTAGE 600V	AC CURRENT 600A
RESISTANCE 60MΩ	CAPACITANCE 60mF	FREQUENCY (A) 1kHz
FREQUENCY (V) 10kHz	FREQUENCY (Hz/Duty) 10MHz	DUTY CYCLE 0.5%~99.9%
TEMPERATURE -20°C~1000°C -4°F~1832°F	DISPLAY COUNTS 6000	26mm 1.0"



FEATURES

Display counts	6000
Jaw opening	Ø26mm/1.0"
Auto Ranging	•
Manual Ranging	•
APO	Auto Power OFF
NCV	Non-Contact Voltage Detector
Diode	Open Voltage
Continuity Buzzer	<60Ω
Data Hold	•
Display Backlight	•
Work light	•
LBD	Low battery display

GENERAL

Power Supply	3×1.5V AAA Batteries included
Product Size	218mm×78mm×35mm/8.9"×3.1"×1.4"
Product Weight	239g/0.53lb
Certificate	RoHs, CE, ETL
Safety Rating	CAT III 600V

PACKAGING & LOGISTICS INFORMATION

HS Code: 90303200

Carton box

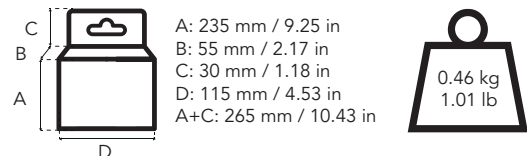

Export carton

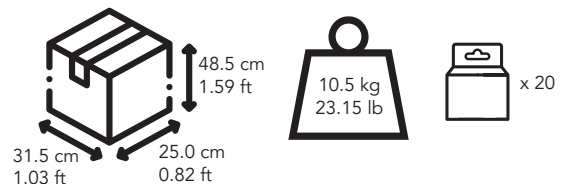

Pallet

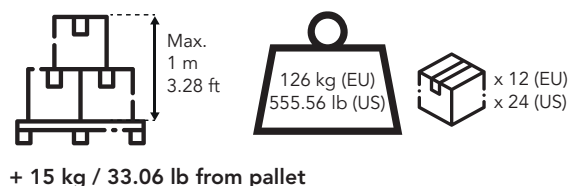

CONTENTS



MAIN APPLICATIONS

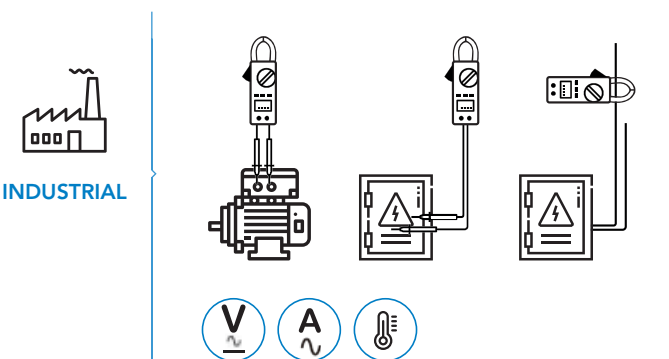
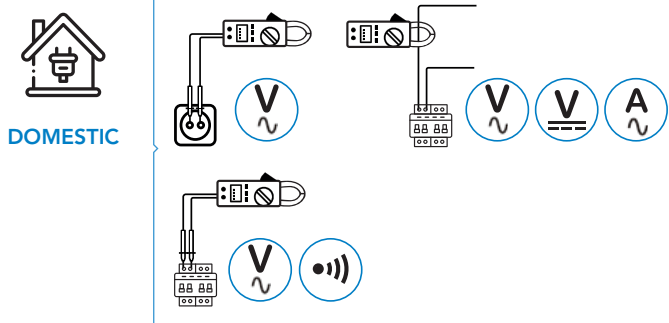



NEW

- Display 2000 counts
- Diode Open Voltage 1.5V
- Jaw Opening $\Phi 26\text{mm}/1.0''$
- Auto & Manual Ranging
- True RMS measurements
- AC/DC Voltage (600V)
- AC current(600A)
- Resistance (20M Ω)
- Diode and Continuity tests
- Data hold
- Backlight
- Maximum measurements



C-LOGIC 840

Digital clamp meter
 SKU No : CLOGIC840CBINT
 EAN Code: 8435394788067
 UPC Code: 810053678428

SPECIFICATIONS

AC VOLTAGE 600V	DC VOLTAGE 600V	DC CURRENT 600A
RESISTANCE 20M Ω	CONTINUITY <50 Ω	JAW OPENING 26mm/1.0"



FEATURES

Display counts	2000
Auto Ranging	•
Auto Power Off	•
True RMS	•
Diode Open Voltage	1.5V
Continuity Buzzer	<50 Ω
Display Backlight	•
Data Hold	•

GENERAL

Power Supply	3x1.5V AAA Batteries
Product Size	208mmx78mmx35mm/8.2" x 3.1" x 1.4"
Product Weight	245g / 0.54lb
Certificate	CE, UKCA, ETL
Safety Rating	CAT III 600V

PACKAGING & LOGISTICS INFORMATION

HS Code: 90303200

Carton box

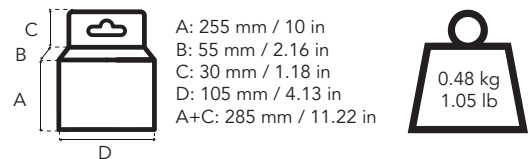

Export carton

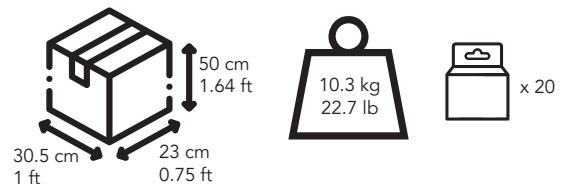

Pallet



CONTENTS

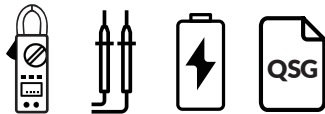

MAIN APPLICATIONS

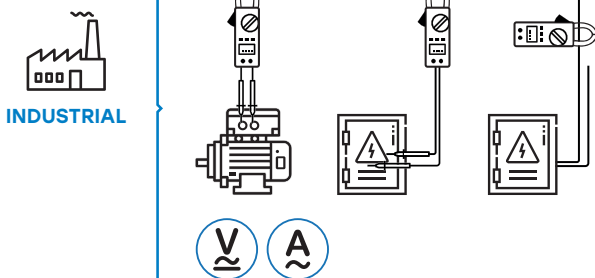
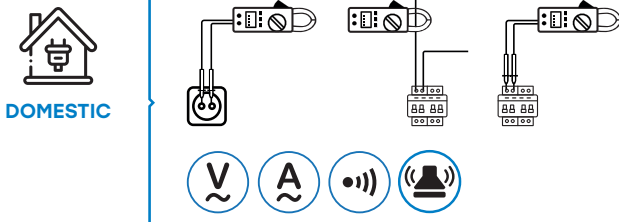



- AC/DC Current, allows work with renewable.
- Double injection housing which facilitates the grip and handling of the clamp.
- True RMS.

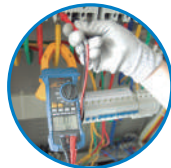

PRO



More info

C-LOGIC 8500

TRMS AC/DC clamp meter 1000A
 SKU No : CLOGIC8500CBINT
 EAN Code : 8435394775531
 UPC Code : 810053671283

CONTENTS



MAIN APPLICATIONS

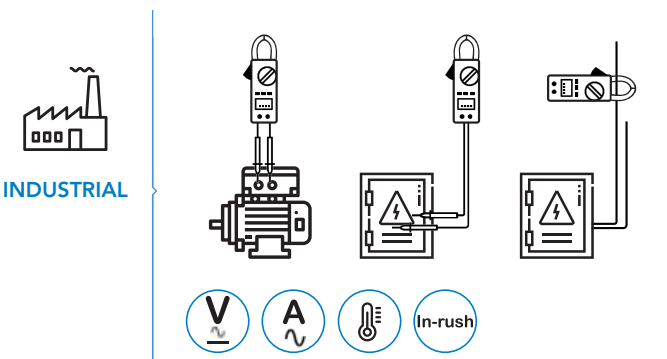
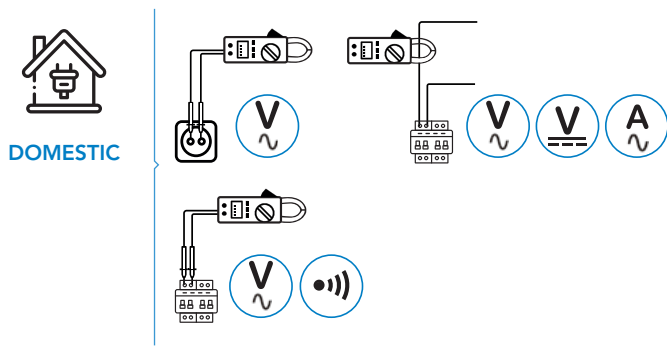

SPECIFICATIONS

AC VOLTAGE 750V	DC VOLTAGE 1000V	AC CURRENT 1000A
DC CURRENT 1000A	INRUSH CURRENT 1000A	RESISTANCE 60MΩ
CAPACITANCE 100mF	FREQUENCY (A/V) 1000Hz/10kHz	FREQUENCY (Hz/Duty) 10MHz
DUTY CYCLE 0.1%~99.9%	DISPLAY COUNTS 6000	40mm 1.6"



FEATURES

Auto Ranging		•
Manual Ranging		•
APO	Auto Power OFF	•
REL	Relative Measurement	•
Diode	Open Voltage	3.2V
Continuity Buzzer	<50Ω	•
Data Hold		•
MAX/MIN		•
LBD	Low Battery Display	•
True RMS	True Root Mean Square	•
Display Backlight		•
Work light		•
Inrush	Inrush Current Measurement	•

GENERAL

Power Supply	1×9V 6F22 Battery included
Product Size	238mm×92mm×50mm/9.37"×3.6"×1.9"
Product Weight	386g/0.85lb
Certificate	RoHs, CE, ETL
Safety Rating	CAT III 1000. CAT IV 600V

PACKAGING & LOGISTICS INFORMATION

HS Code: 90303200

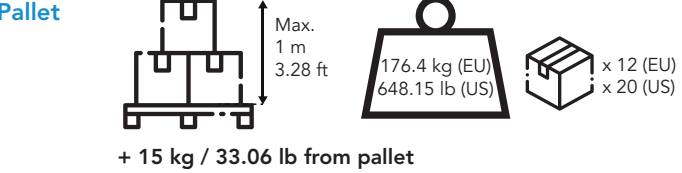
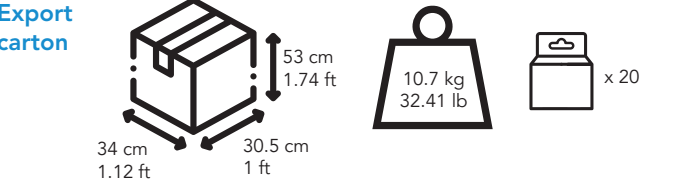
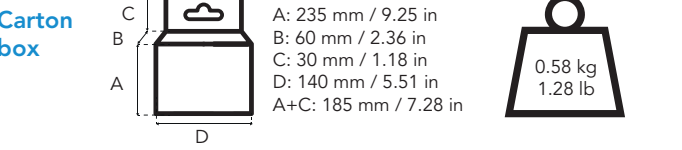



- Double injection housing, which facilitates the grip and handling of the clamp.
- True RMS.
- Professional reference, leakage clamp meter.



PRO

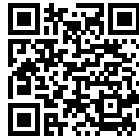

More info

C-LOGIC 8730

Leakage clamp meter with low-pass filter
 SKU No : CLOGIC8730CBINT
 EAN Code : 8435394775623
 UPC Code : 810053671542

CONTENTS



MAIN APPLICATIONS

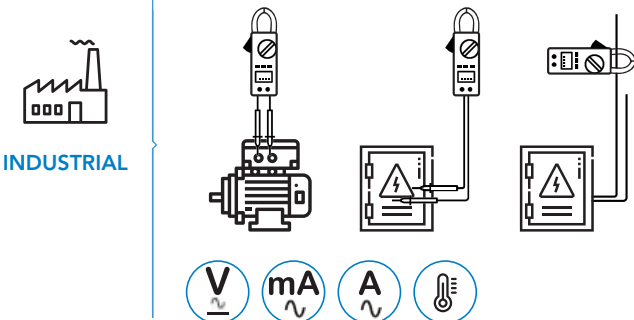
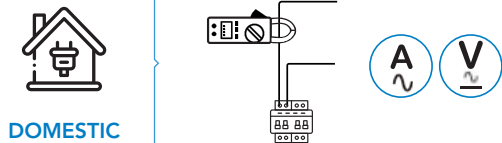

SPECIFICATIONS

AC VOLTAGE 600V	DC VOLTAGE 600V	AC CURRENT 150A
RESISTANCE 40MΩ	CAPACITANCE 40mF	TEMPERATURE -20°C~1000°C -4°F~1832°F
DISPLAY COUNTS 4000	30mm 1.2"	TRMS MAX MIN



FEATURES

Display counts	4000
Jaw opening	Ø30mm/1.2"
Auto Ranging	Auto •
APO	Auto Power OFF •
True RMS	For AC Voltage •
LPF	Low Pass Filter Function (50/60Hz) •
Zero	Zero Adjustment •
MAX/MIN	•
Diode	Open Voltage 3.2V
Continuity Buzzer	<40Ω •
Data Hold	•
LBD	Low Battery Display •

GENERAL

Power Supply	2×1.5V AAA Batteries included
Product Size	213mm×62mm×38mm/8.39"×2.44"×1.5"
Product Weight	238g/0.52lb
Certificate	RoHs, CE, ETL
Safety Rating	CAT III 600V

PACKAGING & LOGISTICS INFORMATION

HS Code: 90303200

Carton box

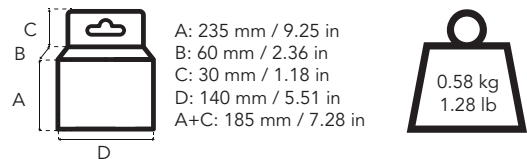

Export carton

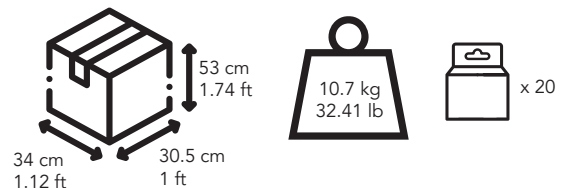

Pallet

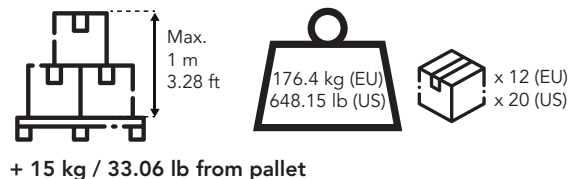



SKU NO.	CLOGIC80CBINT	CLOGIC85CBINT	CLOGIC810CBINT	CLOGIC840CBINT	CLOGIC8500CBINT	CLOGIC8730CBINT
True RMS measurements	-	-	-	√	√	√
Altern current, up to	1000A	400A	600A	600A	1000A	150A
Direct current, up to	-	-	-	-	-	-
Altern voltage, up to	750V	600V	600V	600V	750V	600V
Direct voltage, up to	1000V	600V	600V	600V	1000V	600V
Counts	2000	2000	6000	2000	600	4000
Resistance, up to	20kΩ	-	60MΩ	20MΩ	60MΩ	40MΩ
Frequency, up to	-	-	10MHz	-	10MHz	-
Temperature, up to	-	-	1000°C	-	-	1000°C
Continuity test	√	√	√	√	√	√
Diode test	√	√	√	√	√	√
Capacitance, up to	-	-	60mF	-	100mF	40mF
Non-contact voltage detection	-	√	√	-	√	√
Inrush current	-	-	-	-	√	-
Low pass filter	-	-	-	-	-	√
Power measurements (W, VA, VAR, PF)	-	-	-	-	-	-
Harmonic measurements	-	-	-	-	-	-
Data hold	√	-	√	√	√	√
Relative measurements	-	-	-	-	√	-
MAX/MIN values	-	-	-	MAX	√	√
Autoranging	-	-	√	√	√	√
Jaw size	50mm	28mm	26mm	26mm	40 mm with worklight	30 mm
Auto off	-	-	√	√	√	√
Backlight display	-	-	√	√	√	-
Low battery display	√	√	-	-	√	√
Connectivity	-	-	-	-	-	-
Data logging	-	-	-	-	-	-
Category according to EN61010	CAT II 1000V CAT III 600V	CAT III 600V	CAT III 600V	CAT III 600V	CAT IV 600V CAT III 1000V	CAT III 600V



- Non contact voltage tester 1.000V
- Pen type.



C-LOGIC 25

Voltage Tester up to 1000V
 SKU No : CLOGIC25CBINT
 EAN Code : 8435394777290
 UPC Code : 810053673331



More info

SPECIFICATIONS

AC VOLTAGE
90-1000Vac

FREQUENCY
50/60Hz



FEATURES

Voltage Range	90-1000V AC	
Frequency	50/60HZ	
NCV	Non-Contact AC Voltage Detector •	
Sound & LED indicator	•	

GENERAL

Power Supply	2 x1.5V AAA
Product Size	148 x 17 x 26 mm
Product Weight	23 gr. (without batteries)
Certificate	CE
Safety Rating	CAT II 1000V

PACKAGING & LOGISTICS INFORMATION

HS Code: 90303200

Carton box

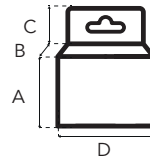

A: 152 mm / 5.98 in
 B: 32 mm / 1.25 in
 C: 23 mm / 0.9 in
 A+C: 175 mm / 6.88 in



Export carton

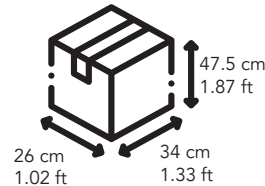

26 cm / 1.02 ft
 34 cm / 1.33 ft
 47.5 cm / 1.87 ft



Pallet

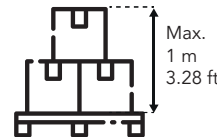

Max.
1 m / 3.28 ft



+ 15 kg / 33.06 lb from pallet

CONTENTS



MAIN APPLICATIONS

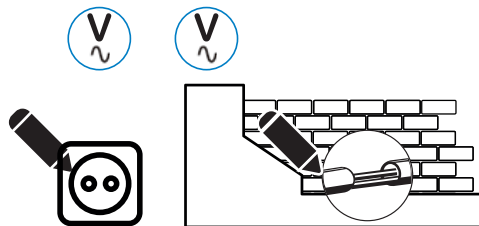



- Pen type which facilitates product portability.
- Metal detection.
- Sound and light signals.



C-LOGIC 35

Adjustable non contact AC voltage tester
 SKU No : CLOGIC35CBINT
 EAN Code : 8435394747903
 UPC Code : 810053670859



More info

SPECIFICATIONS

AC VOLTAGE
20-1000V



FEATURES

Frequency	50Hz~500Hz
Sound and light Indication	•
Red and Green LED Light	•
Double Molded Case	•
Metal Detecting Distance	<20mm
AC Voltage Sensitivity adjustment	•
Memory Sensitivity function	•
Auto Power Off	•
Low Battery Indication	•
Operating Temperature	-10°C~50°C

GENERAL

Storage Temperature	-20°C~60°C
Humidity	<85%RH
Altitude	<2000m
Product size	157mm×24mm×20 mm 6.18"×0.94"×0.78"
Product weight	42g/0.09lb
Certificate	CE/ETL/RoHs
Safety rating	CAT II 1000V/CAT III 600V
Power supply	2×12V A23S included

PACKAGING & LOGISTICS INFORMATION

HS Code: 90303200

Carton box

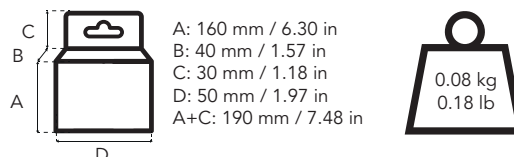

Export carton

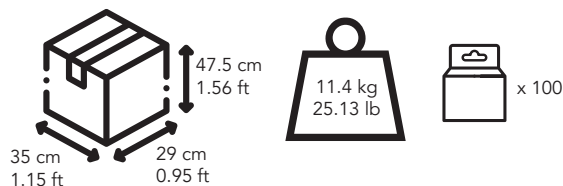

Pallet

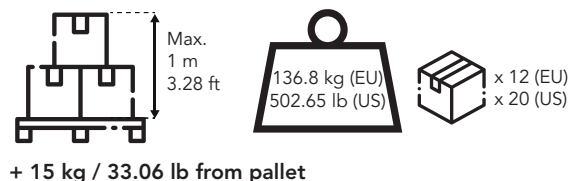

CONTENTS



MAIN APPLICATIONS

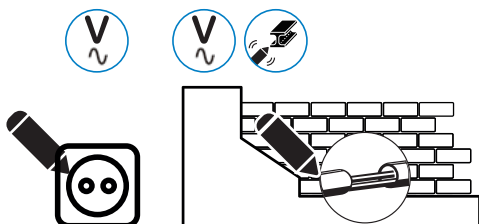



- Ergonomic design that facilitates its use
- Rubber housing for better confort in use.
- Small size, ideal for transport.



C-LOGIC 350

Two pole voltage tester
 SKU No : CLOGIC350CBINT
 EAN Code : 8435394747910
 UPC Code : 810053671290



More info

SPECIFICATIONS

AC VOLTAGE
 12-24-50-120-230-400V

FREQUENCY
 50Hz/60Hz

ACCURACY
 -30%~0%
 of indication



FEATURES

Altitude	<2000m
Operation time	Maximum 30s
Recovery time	10 minutes
Relative humidity	<80%RH
Temperature range	-10~55°C/14~131°F

GENERAL

Power Supply	N/A
Product Size	223mmx40mmx32 mm/8.78"x1.57"x1.26"
Product Weight	98.5g/0.26lb
Certificate	RoHs, CE, ETL
Safety Rating	CAT III 400V

PACKAGING & LOGISTICS INFORMATION

HS Code: 90303200

Carton box

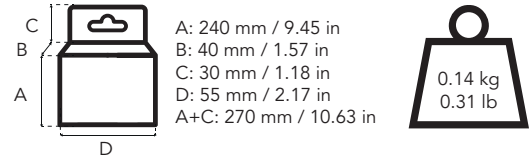

Export carton

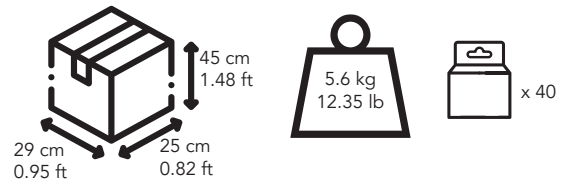

Pallet

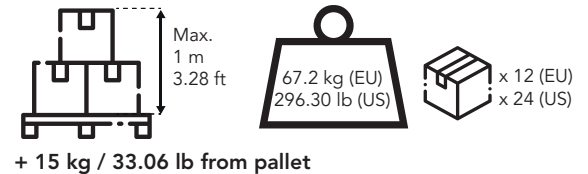

CONTENTS



MAIN APPLICATIONS

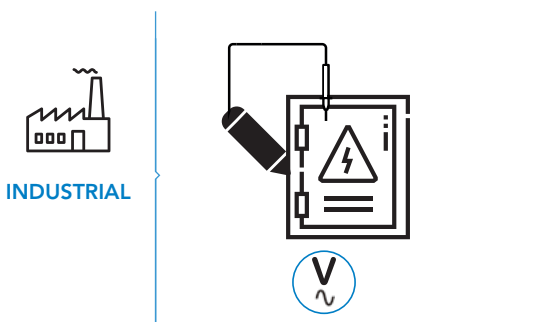
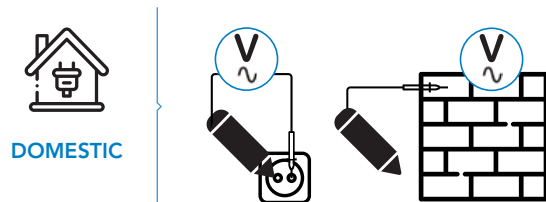

FUNCTIONS			
	C-LOGIC 25	C-LOGIC 35	C-LOGIC 350
SKU NO.	CLOGIC25CBINT	CLOGIC35CBINT	CLOGIC350CBINT
TRMS	-	-	-
Altern voltage	Non-contact	Non-contact	12V, 24V, 50V, 120V, 230V, 400V
Direct voltage	-	-	12V, 24V, 50V, 120V, 230V, 400V
Non-contact voltage detection	90-1000 VAC	12-1000 VAC	12-1000 VAC
Frequency	50/60 Hz	50/50 Hz	50/50 Hz
AC current	-	-	-
Resistance	-	-	-
Single pole test	-	-	-
Phase rotation test	-	-	-
Acoustic indication	✓	✓	-
Visual indication (LEDs)	✓	✓	✓
Polarity	-	-	✓
Category according to EN61010	CAT II 1000V	CAT III 600V CAT II 1000V	CAT III 400V



- Rubber housing for better confort in use.
- Valid for LED.
- Profesional reference.



PRO



More info

C-LOGIC 250

Digital light meter
 SKU No : CLOGIC250CBINT
 EAN Code : 8435394747958
 UPC Code : 810053671511

CONTENTS



MAIN APPLICATIONS

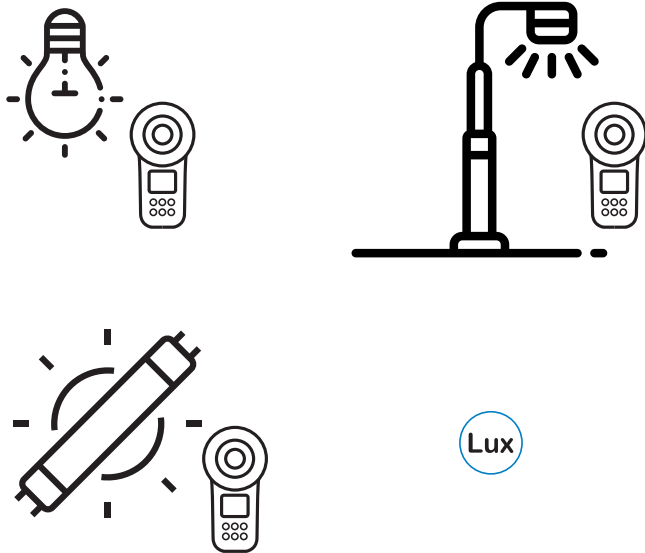

SPECIFICATIONS

LUX 20.000	DISPLAY COUNTS 2000	H REL
Apo	MAX MIN	Lux CD FC
		OK Led

FEATURES

Display counts	2000
Auto Ranging	•
Manual Ranging	•
APO	Auto Power OFF
MAX/MIN	•
REL	Relative Measurement
PEAK	Peak Measurement
ZERO	Zero Calibration
FC / Lux	FC / Lux / Unit Selection
Data Hold	•
Analog Bar	Analog Bar Indication
LBD	Low Battery Display

GENERAL

Power supply	1×9V 6F22 Battery included
Product size	170mm×89mm×43mm/6.7"×3.5"×1.7"
Product weight	420g/0.93lb
Certificate	RoHs, CE, ETL

PACKAGING & LOGISTICS INFORMATION

HS Code: 90303200

Carton box

A: 190 mm / 7.48 in
 B: 60 mm / 2.36 in
 C: 30 mm / 1.18 in
 D: 110 mm / 4.33 in
 A+C: 220 mm / 8.66 in

0.33 kg / 0.73 lb

Export carton

33.5 cm / 1.10 ft
 40 cm / 1.31 ft
 24 cm / 0.79 ft

6.8 kg / 14.99 lb

x 20

Pallet

Max. 1 m / 3.28 ft

149.6 kg (EU) / 419.76 lb (US)

x 22 (EU) / x 28 (US)

+ 15 kg / 33.06 lb from pallet



- Rubber housing for better comfort in use.
- Small size ideal for transport.
- Temperature range up to 300°C.
- Data hold.



PRO



More info

C-LOGIC 230

Infrared thermometer
 SKU No : CLOGIC230CBINT
 EAN Code : 8435394775848
 UPC Code : 810053670002

CONTENTS



MAIN APPLICATIONS

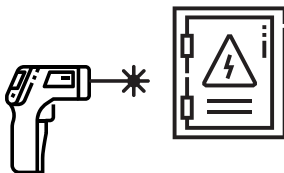
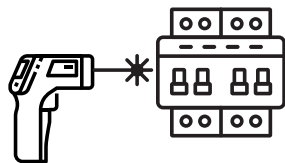
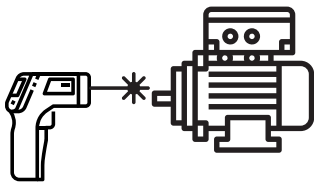

SPECIFICATIONS

TEMPERATURE
 -20°C~300°C
 -4°F~572°F

REL. HUMIDITY
 10%~90%

RESOLUTION
 0.1°C/0.2°F



FEATURES

Spectral Response	8-14 μm	•
Laser	<1mW / 630-670nm	•
°C/°F Selection		•
Response time	1 second	•
Relative Humidity	10%~90%	•
Laser Target Pointer		•
Reading Hold		•
MAX		•
MIN/AVG		•
Display Backlight		•
LBD	Low Battery Display	•

GENERAL

Power supply	2x1.5V AAA Batteries included
Product size	148mmx90mmx50mm/5.8"x3.54"x1.96"
Product weight	135g/0.3lb
Certificate	RoHs, CE, ETL

PACKAGING & LOGISTICS INFORMATION

HS Code: 90251900

Carton box

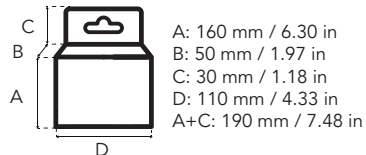

Export carton

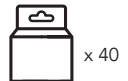
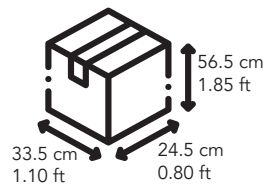

Pallet

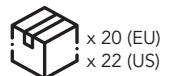
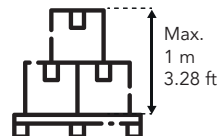

+ 15 kg / 33.06 lb from pallet



- Rubber housing for better comfort in use.
- 40 m/s, Temperature, HR%
- Professional reference.



PRO



More info

C-LOGIC 280

Anemometer

SKU No : CLOGIC280CBINT

EAN Code : 8435394747941

UPC Code : 810053671306

CONTENTS



MAIN APPLICATIONS

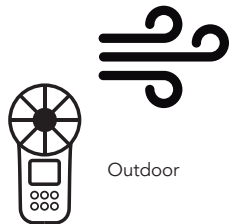
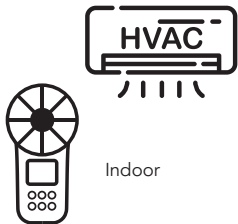

SPECIFICATIONS

Air speed (m/s) 40.00	Air speed (km/h) 144.0	Air speed (ft/s) 131.2
Air speed (mile/h) 90.00	Air speed (ft/min) 7874	Air speed (knots) 77.70
TEMPERATURE -10°C~60°C 14°F~140°F	RELATIVE HUMIDITY <20%~>80%	DISPLAY COUNTS 9999



FEATURES

	Range	Area	
Air Volume Unit	CFM: 0~999.9	0~9.999 ft ²	•
	CMM: 0~999.9	0~9.999 m ²	•
	CFS: 0~999.9	0~9.999 m ²	•
Display counts			9999
Flow Area Setting			•
MAX/MIN			•
Data Hold			•
Display Backlight			•
LBD	Low Battery Display		•

GENERAL

Power supply	1×9V 6F22 Battery included
Product size	165mm×85mm×38mm/6.5"×3.3"×1.5"
Product weight	168g/0.37lb
Certificate	RoHs, CE, ETL

PACKAGING & LOGISTICS INFORMATION

HS Code: 90303200

Carton box

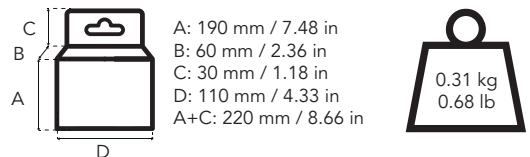

Export carton

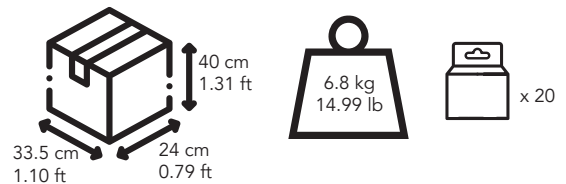

Pallet

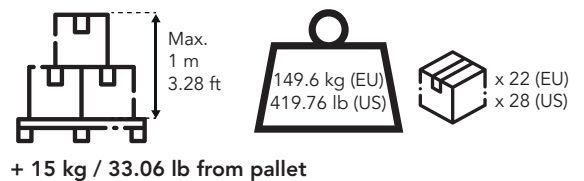



- Rubber housing for better confort in use.
- Up to 130dB.
- Categories A/C.
- Professional reference.



PRO



More info

C-LOGIC 290

Sound level meter
 SKU No : CLOGIC290CBINT
 EAN Code : 8435394747965
 UPC Code : 810053671528

CONTENTS



MAIN APPLICATIONS

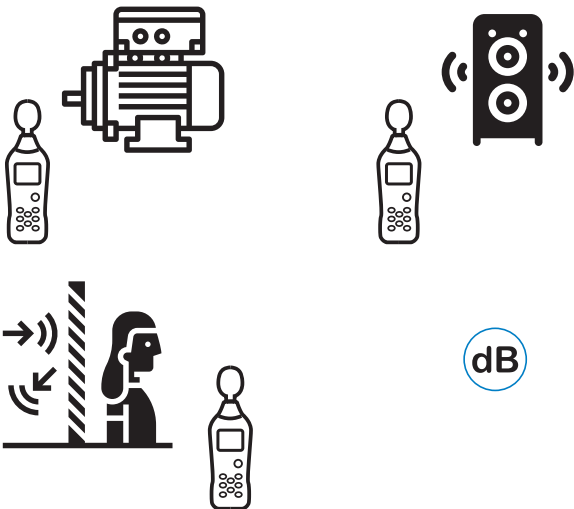

SPECIFICATIONS

SOUND PRESSURE
30dB~130dB

DISPLAY COUNTS
2000



FEATURES

Display counts		2000
Auto Ranging	Auto & Manual	•
APO	Auto Power Off	•
Dynamic	50dB	•
Frequency	30Hz~8kHz	•
Sample Rate	2 times/second	•
Fast/Slow	125ms/1 sec	•
A/C Weighting		•
Display Backlight		•
LBD	Low Battery Display	•
Analog Bar	Analog Bar Indication	•
UNDER/OVER	Over Range Indication	•

PACKAGING & LOGISTICS INFORMATION

HS Code: 90303200

Carton box

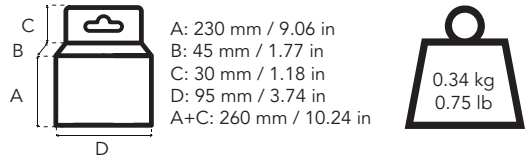

Export carton

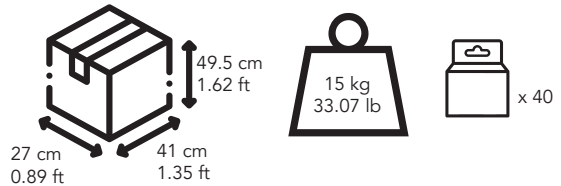

Pallet

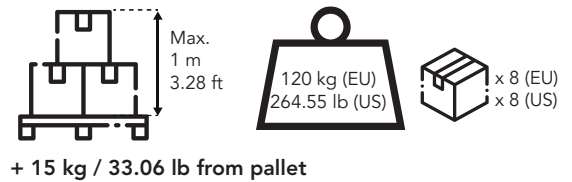



- Correct wiring tester
- Indication of disconnected poles L,N,E
- Sound and light led indicators



C-LOGIC 380

Socket tester



More info



ARTICLE	C-LOGIC 380	C-LOGIC 380US	C-LOGIC 380UK
SKU No.	CLOGIC380CBINT	CLOGIC380USCBINT	CLOGIC380UKCBINT
EAN	8435394747927	8435394776729	8435394776934
UPC	-	810053670897	-

SPECIFICATIONS

AC VOLTAGE
230V



FEATURES

Voltage Range	230V
LED indication of the socket's wiring	Correct
	Missing Earth
	Live-Earth reverse
	Live-Neutral reverse
	Missing Neutral

GENERAL

Product Size	68mm×60mm×56mm/2.67"×2.36"×2.2"
Product Weight	60g/0.13lb
Certificate	RoHs, CE, ETL
Safety Rating	CAT II 230V

PACKAGING & LOGISTICS INFORMATION

HS Code: 90318000
HS Code (UK): 90303200

Carton box

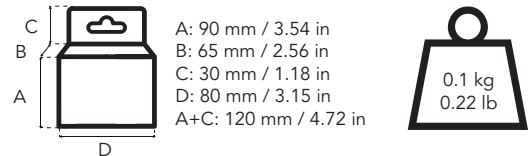

Export carton

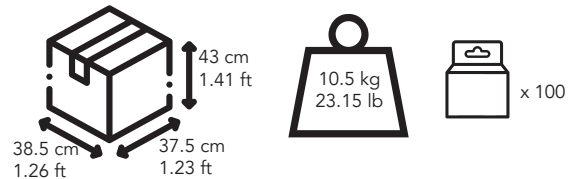

Pallet

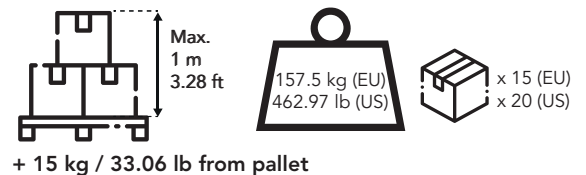

CONTENTS



AVAILABLE SOCKETS



MAIN APPLICATIONS

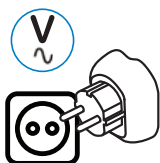

TONE	
ON	● ● ● CORRECT
o) PULSE	● ● ● MISSING EARTH
o) PULSE	● ● ● LIVE EARTH REVERSE
o) PULSE	● ● ● LIVE NEUTRAL REVERSE
o) PULSE	● ● ● MISSING NEUTRAL



- Allows for easy AC current measurements.
- Separates Live conductor from the neutral and ground.
- Include terminals for voltage measurements.
- Compatible with Schuko.



SPECIFICATIONS

AC VOLTAGE
250V

AC CURRENT
15A

X1 - X10
AC CURRENT

FEATURES

- Allows for easy AC current measurements
- Provides the ability to safely measure current
- Separates de Hot/Live conductor from the neutral and ground
- Voltage check sockets for easy power calculations

GENERAL

Product size 200mm×57mm×48mm/7.8"×2.2"×2.9"

Product weight 140g/0.3lb

Certificate RoHs, CE

Safety rating CAT II 600V

PACKAGING & LOGISTICS INFORMATION

HS Code: 90303200

Carton box

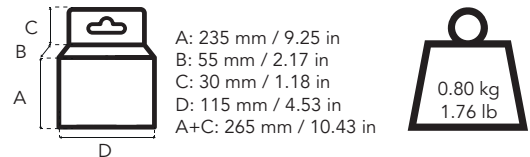

Export carton

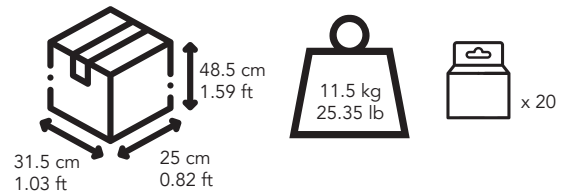

Pallet

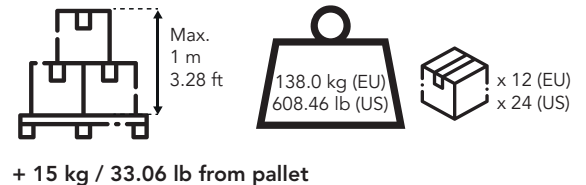

C-LOGIC 370 AC Line splitter



More info



ARTICLE	C-LOGIC 370	C-LOGIC 370US	C-LOGIC 370UK
SKU No.	CLOGIC370CBINT	CLOGIC370USCBINT	CLOGIC370UKCBINT
EAN	8435394775692	8435394776736	8435394776941
UPC	-	810053670880	-

CONTENTS



AVAILABLE SOCKETS



MAIN APPLICATIONS

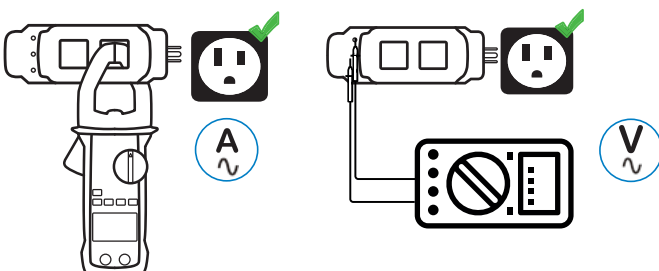



- Multifunction.
- Rubber housing for better confort in use.
- Small size ideal for transport.
- RJ11, RJ45 and coaxial cables.
- Cable tester and tracker.
- State of the telephone lines.



PRO



C-LOGIC 3400

Multifunction cable tracker
 SKU No : CLOGIC3400CBINT
 EAN Code : 8435394775647
 UPC Code : 810053670842



More info



Applications

- Testing RJ45 cable
- Testing RJ11 cable
- Testing Coaxial Cable (BNC)
- Twisted-wire-pair cables (RJ45): 10Base-T, T568, T568, Token Ring
- Testing Cable's Shield Integrity
- Judge Continuity of the Cables or Wires
- Track the cables or wire, and diagnose the break Point
- Receive the tone signal on the cables or wires (telephone line)
- Identify the state in the working telephone line (clear, ringing, busy)
- Send a Single Solid or a Dual Alternating Tone to the Target Cables or Wires

FEATURES

- Send tone frequency: 1-5kHz
- Receive frequency: 100Hz~300kHz

GENERAL

Power supply	2x9V 6F22 included
Product size	206mm×84mm×55mm/8.1"×3.3"×2.1"
Product weight	330g/0.72lb
Certificate	CE/ETL/RoHS

PACKAGING & LOGISTICS INFORMATION

HS Code: 90303200

Carton box

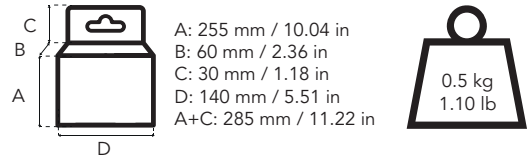

Export carton

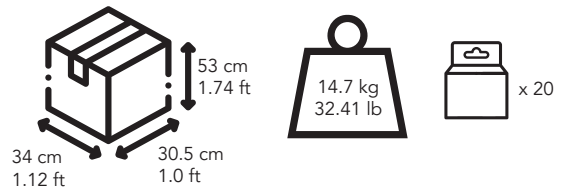

Pallet

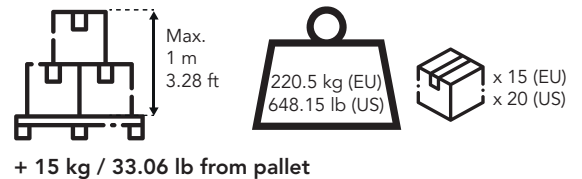

CONTENTS

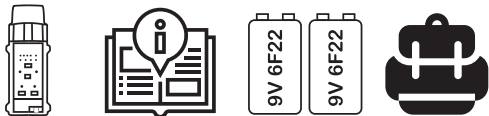

MAIN APPLICATIONS

Cable error tracking

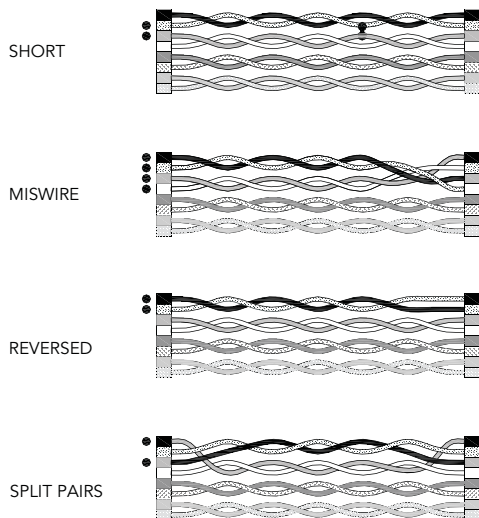



- Socket tester and circuit breaker finder.
- Sound and light signals
- Professional reference.



PRO



More info

C-LOGIC 3600 Circuit breaker finder



ARTICLE	C-LOGIC 3600	C-LOGIC 3600US	C-LOGIC 3600UK
SKU No.	CLOGIC3600CBINT	CLOGIC3600USCBINT	CLOGIC3600UKCBINT
EAN	8435394775685	8435394776743	8435394776958
UPC	-	810053670873	-

CONTENTS

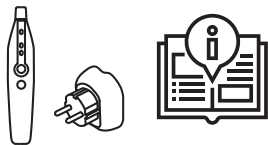

AVAILABLE SOCKETS



MAIN APPLICATIONS

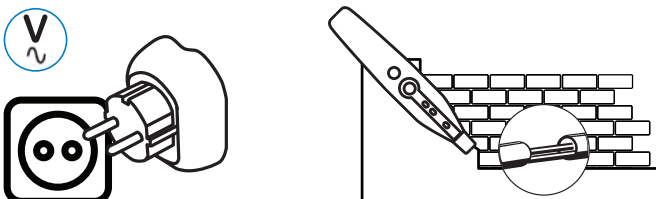

TONE	ON	CORRECT
o)) PULSE	● ● ●	MISSING EARTH
o)) PULSE	● ● ●	LIVE EARTH REVERSE
o)) PULSE	● ● ●	LIVE NEUTRAL REVERSE
o)) PULSE	● ● ●	MISSING NEUTRAL

SPECIFICATIONS

AC VOLTAGE

230V

SOCKET TEST

FEATURES

AC Voltage Range	230V
Socket Test	206mm×84mm×55mm/8.1"×3.3"×2.1"
Receiver + Transmitter	Quickly and easily identify the breaker connected to a specific socket
Transmitter (Socket Tester Mode) LED indication of the socket's wiring	Correct Missing earth Live-earth reverse Live-neutral reverse Missing neutral
Receiver	Work Light at the Head Points to the Target Area. Low Battery Indication Buzzer and LED instructions

GENERAL

Power Supply	1x9V 6F22 Battery	
Product Size	Receiver	198x40x50mm 7.8"×1.57"×1.97"
	Transmitter	71x64x55mm 2.8"×2.5"×2.16"
Product Weight	Receiver	126g/0.28lb
	Transmitter	60g/0.13lb
Certification	Receiver + Transmitter CE/ETL/RoHS	
Safety Rating	CAT II 600V	

PACKAGING & LOGISTICS INFORMATION

HS Code (EU): 90318000
HS Code (UK/US): 90303200

Carton box

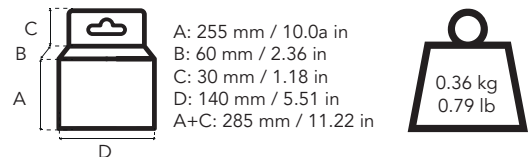

Export carton

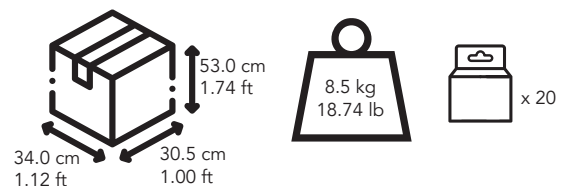

Pallet

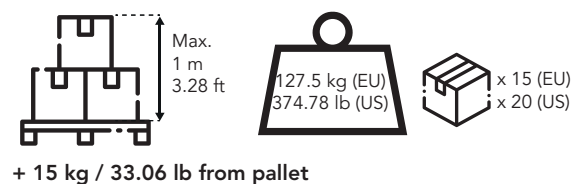



- Rubber housing for better confort in use.
- Non contact type.
- Professional reference.



PRO



More info

C-LOGIC 95

Non-contact type tachometer
 SKU No : CLOGIC95CBINT
 EAN Code : 8435394747996
 UPC Code : 810053671535

CONTENTS



MAIN APPLICATIONS

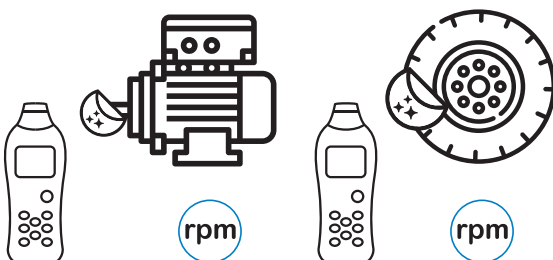

SPECIFICATIONS

RPM
50~99999



FEATURES

Measuring Distance	50mm~250mm	
APO	Auto Power Off	•
MAX/MIN		•
Data Logging	100 groups	•
Data Hold		•
Display Backlight		•
LBD	Low Battery Display	•

GENERAL

Power supply	4x1.5AAA Batteries included
Product size	155mm×60mm×27mm/6.1"×2.4"×1.1"
Product weight	120g/0.26lb
Certificate	RoHs, CE, ETL

PACKAGING & LOGISTICS INFORMATION

HS Code: 90303200

Carton box

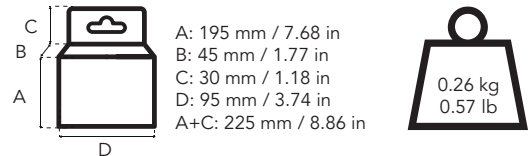

Export carton

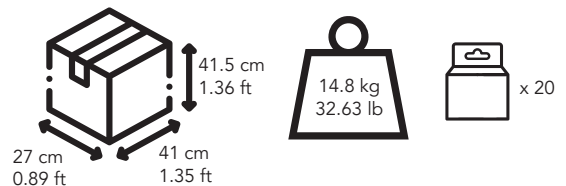

Pallet

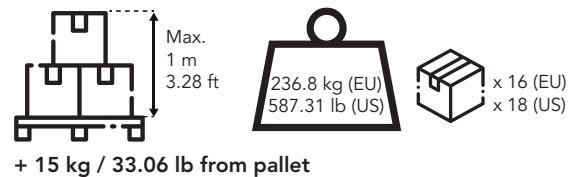



- Motor & phase rotation tester
- Led light signals.



PRO



More info

C-LOGIC 98

Motor & Phase rotation tester
 SKU No : CLOGIC98CBINT
 EAN Code : 8435394775708
 UPC Code : 810053671573

SPECIFICATIONS

Nominal Voltage
 Rotary Direction
 1~400V AC

Nominal Voltage
 Phase Indication
 120~400V AC

Frequency
 2~400Hz

Test Currents
 (In per phase)
 Less than 3.5 mA



FEATURES

Operating TEMP	0~40°C
Operating Altitude	2000m
Pollution Degree	2
Relative Humidity	15~80%RH

GENERAL

Power supply	1×9V 6F22 Battery included
Product size	130mm×72mm×32mm/5.1"×2.8"×1.3"
Product weight	252g/0.6lb
Certificate	CE, ETL
Safety Rating	CATIII 600V

PACKAGING & LOGISTICS INFORMATION

HS Code: 90303200

Carton box

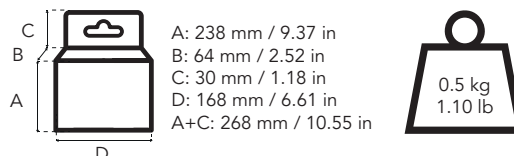

Export carton

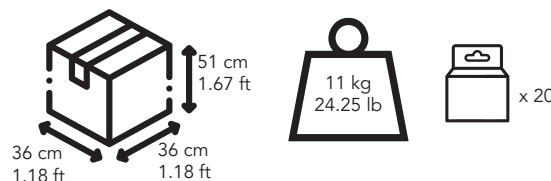

Pallet

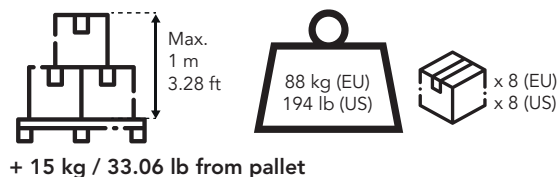

CONTENTS



MAIN APPLICATIONS

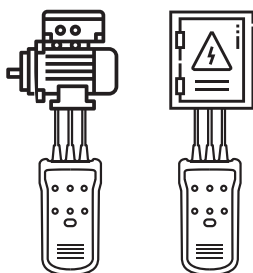

⊗ ON ○ OFF ⊙ NOT DEFINED

DISPLAY	↻	↺	L1/A	L2/B	L3/C
Rotat.Right	○	⊗	⊗	⊗	⊗
Rotat.Left	⊗	○	⊗	⊗	⊗
L1 MISSING	⊙	⊙	○	⊗	⊗
L2 MISSING	⊙	⊙	⊗	○	⊗
L3 MISSING	⊙	⊙	⊗	⊗	○

Un=400/230V AC Ume=1...400V AC fn=2...400Hz



Containing the suitable tools test and measurements on Low voltage installations:

- **Digital Multimeter C-LOGIC 50**
500Vac/dc-200mA/dc/2MΩ
- **Handheld metal detector**
 - Suitable for indoor decoration use
 - When detect metal or voltage wire, the detector has sound and flash alarm
 - Can detect metal and voltage wire inside wall
- **Voltage detector**
VAC/DC 12-220V

C-LOGIC 310

SKU No : CLOGIC310CSINT
EAN Code : 8435394775555



More info

SPECIFICATIONS

• C-LOGIC 50 Digital multimeter

AC VOLTAGE 500V	DC VOLTAGE 500V	DC CURRENT 200mA
RESISTANCE 2MΩ	DISPLAY COUNTS 2000	

• Voltage detector

AC VOLTAGE 12-220VAC/DC	
----------------------------	--

• Handheld metal detector

		NCV	
--	--	-----	--

C-LOGIC 50	General	Handheld metal detector	Voltage detector
Product size	120x70x20mm	150x78x24mm	140x26x20mm
Product Weight	202g/0.44lb		60g/0.13lb
Certificate	CE	CE	CE
Safety Rating	CAT III 600V	CAT II 300V	CAT II 300V

PACKAGING & LOGISTICS INFORMATION

HS Code: 90303200

Different packaging options under request.

CONTENTS



MAIN APPLICATIONS

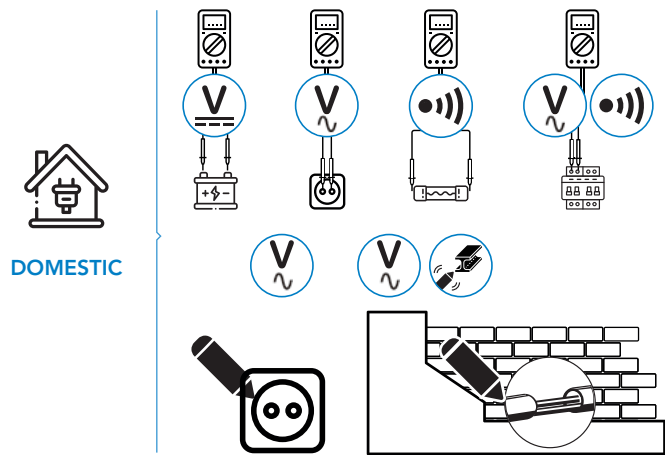

DOMESTIC

ELECTRONICS

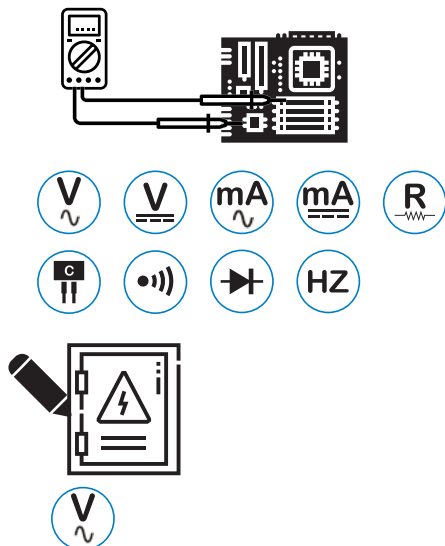



C-LOGIC 324

Test leads
SKU NO : CLOGIC324PEINT

MAIN FEATURES

- Probe Length: 119mm/ø9mm
- Length: 800mm
- Tip: ø2mm / Plug: ø4.5mm
- Wire: UL 1803/20AWG
- MAX 10A
- CAT III 1000V



C-LOGIC 322

Test leads
SKU NO : CLOGIC322PEINT

MAIN FEATURES

- Nickel-plated anti-corrosion metal tips.
- CAT IV 600V



C-LOGIC 325

Big size cocodriles
SKU NO : CLOGIC325PEINT

MAIN FEATURES

- Length: 87mm
- ø4mm cross plug
- Max 32A

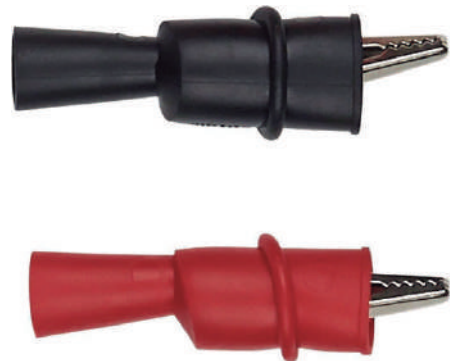

C-LOGIC 323

Big size cocodriles
SKU NO : CLOGIC323PEINT

MAIN FEATURES

- Big size crocodiles
- CAT IV 600V



ENERGY SAVING

- MOVEMENT DETECTORS
- SENSOR LIGHTS
- LIGHT CONTROLS
- DOORCHIMES
- SECURITY DETECTORS
- THERMOSTATS & CHRONOTHERMOSTATS
- TIMES SWITCHES

SYMBOL	DESCRIPTION	SYMBOL	DESCRIPTION
	Power Supply		Light indicators
	Adjustment twilight		Manual control
	Delay time		Auto mode
	Protection degree		Backlight display
	UV Protection		Frost protection
	Suitable for LED lights		Suitable for heating and cooling units
	Head rotation		Suitable for heating units
	E27 installation		Holiday mode
	Sound level		Programming intervals
	Adjustable detection area		Setting temperature range
	Additional output		Max. communication distance
	Lux level adjustment		Communication between devices
	Surge protection		Alexa connectivity
	Cable class		Android connectivity
	Battery class		iOS connectivity
	Number of melodies		TUYA connectivity



- Mini format for wall-mounting installation
- Horizontally and vertically adjustable head
- 180° coverage and maximum reach of 12 m.

ZCS TECHNOLOGY
Zero Cross Switching



More info

C-LOGIC 610-MD

Wall mini movement detector
SKU No : CLOGIC610MD230VCBINT
EAN Code : 8435394748023

CONTENTS

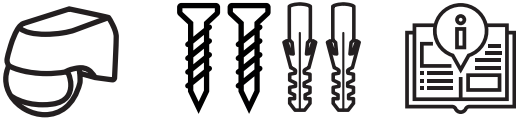

MAIN APPLICATIONS

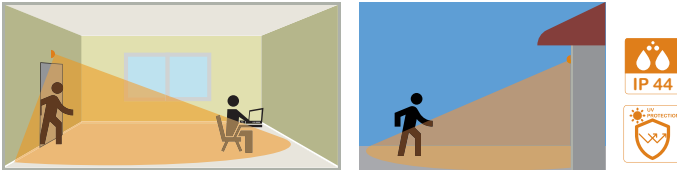

CONNECTION GUIDE

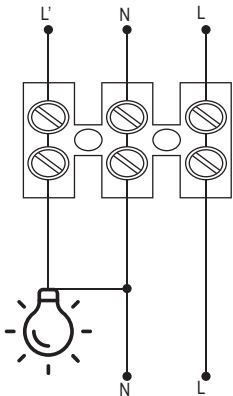

DIMENSIONS

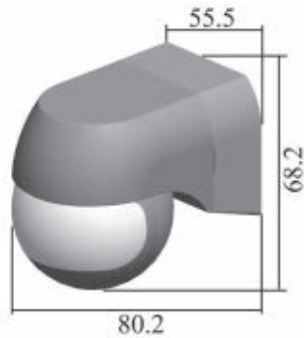

INSTALLATION

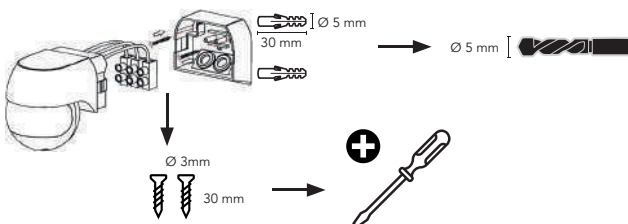

SPECIFICATIONS

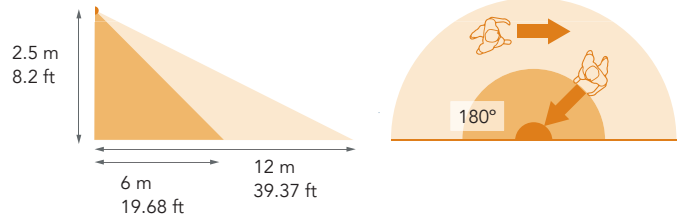

FEATURES

Angle of coverage	180°
Area of coverage	12 m (at 2.5 m height)
Adjustment twilight	3 - 2000 lux
Contact capacity	Incandescence: 800W Energy saving lamps: 400W LED lamps: 400W
Supply voltage	220-240VAC 50/60Hz

PACKAGING & LOGISTICS INFORMATION

HS Code: 85365080

Carton box

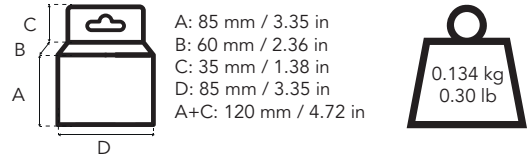

Export carton

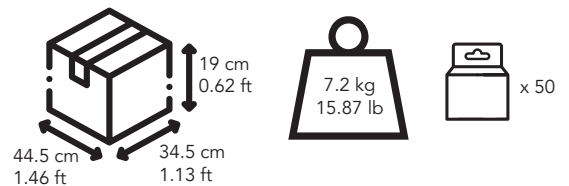

Pallet

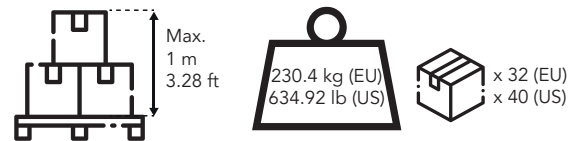

+ 15 kg / 33.06 lb from pallet



- Protection degree IP65, suited for outdoor use.
- Horizontally and vertically adjustable head
- 180° coverage and maximum reach of 12 m.

ZCS TECHNOLOGY
Zero Cross Switching



C-LOGIC 615-MD

Outdoor movement detector
SKU No : CLOGIC615MD230VCBINT
EAN Code : 8435394748030



More info

SPECIFICATIONS

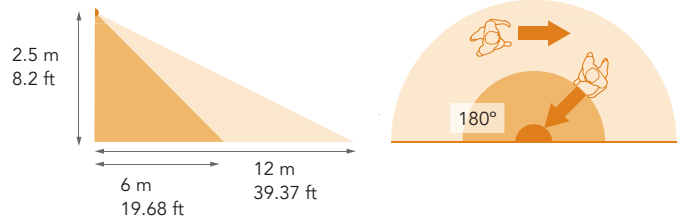

FEATURES

Angle of coverage	180°
Area of coverage	12 m (at 2.5 m height)
Adjustment twilight	3 - 2000 lux
Contact capacity	Incandescence: 800W Energy saving lamps: 300W LED lamps: 200W
Supply voltage	220-240VAC, 50/60Hz

PACKAGING & LOGISTICS INFORMATION

HS Code: 85365080

Carton box

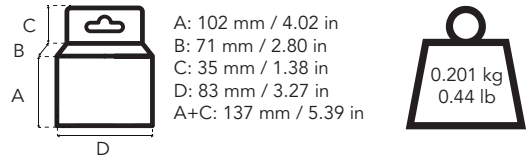

Export carton

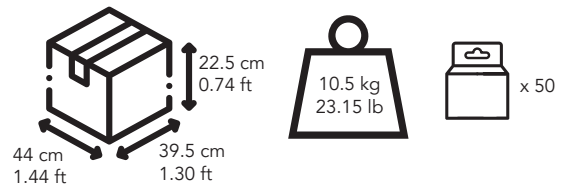

Pallet

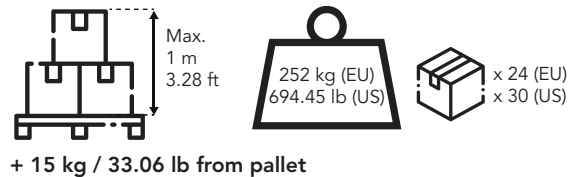

CONTENTS

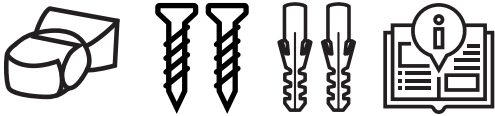

MAIN APPLICATIONS

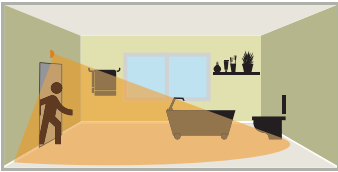

CONNECTION GUIDE

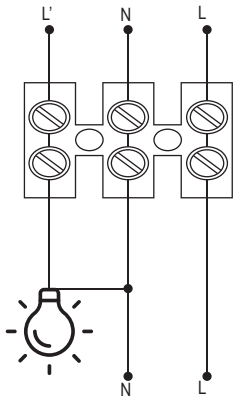

DIMENSIONS

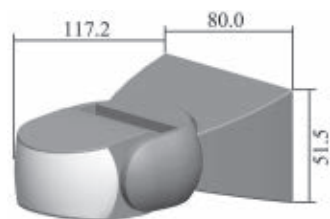

INSTALLATION

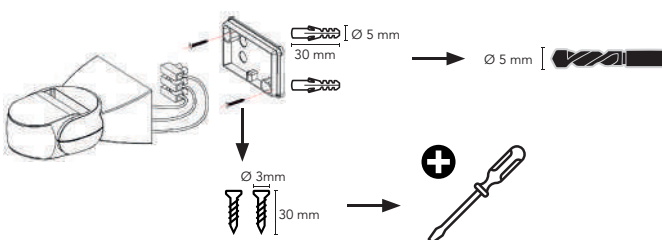



- Led indicator of movement detection
- Externally accessible potentiometer
- 360° detection coverage.

ZCS TECHNOLOGY
Zero Cross Switching



C-LOGIC 620-MD

Ceiling mounting movement detector
SKU No : CLOGIC620MD230VCBINT
EAN Code : 8435394748047



More info

CONTENTS

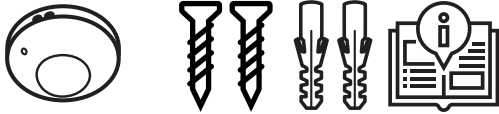

MAIN APPLICATIONS

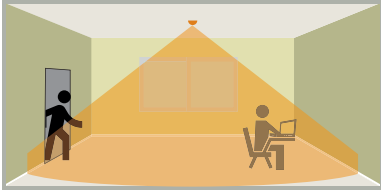

CONNECTION GUIDE

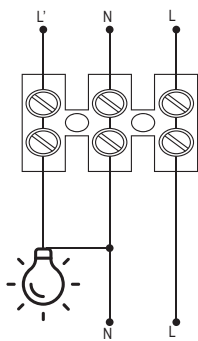

DIMENSIONS



INSTALLATION

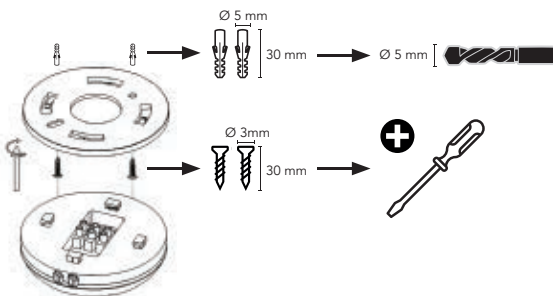

SPECIFICATIONS

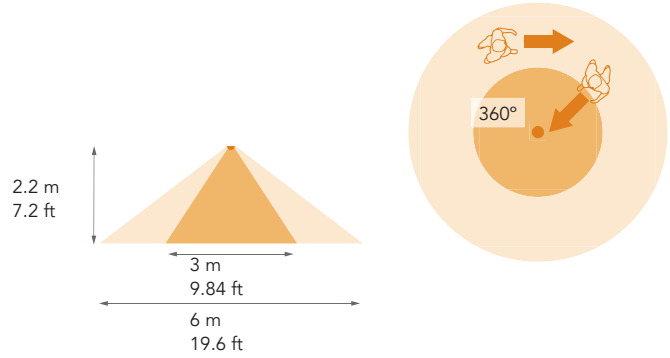

FEATURES

Angle of coverage	360°
Area of coverage	6 m diameter (at 2.2 m height)
Adjustment twilight	3 - 2000 lux
Contact capacity	Incandescence: 1200W Energy saving: 300W LED lamps: 300W
Supply voltage	220-240VAC 50/60Hz

PACKAGING & LOGISTICS INFORMATION

HS Code: 85365080

Carton box

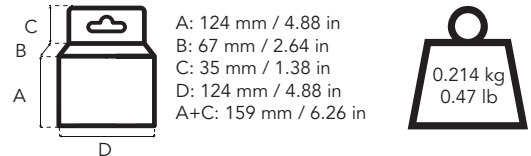

Export carton

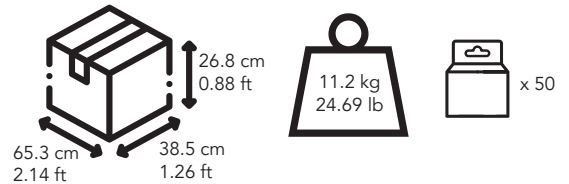

Pallet

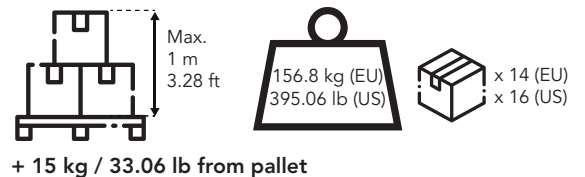



- Ceiling mounting slim line presence detector, only 2 cm high
- The same 360° coverage as other ceiling mounting conventional detectors
- 2000W relay with high switching power.

ZCS TECHNOLOGY
Zero Cross Switching



C-LOGIC 625-MD

Ceiling mounting slimline presence detector
SKU No : CLOGIC625MD230VCBINT
EAN Code : 8435394748054



More info

CONTENTS



MAIN APPLICATIONS

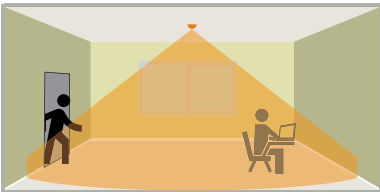

CONNECTION GUIDE

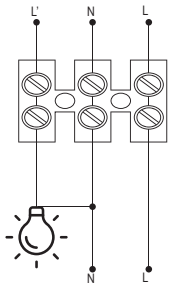

DIMENSIONS



INSTALLATION

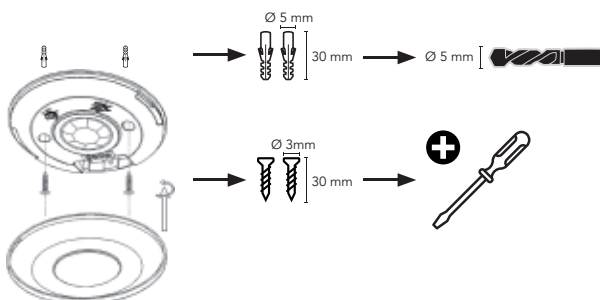

SPECIFICATIONS

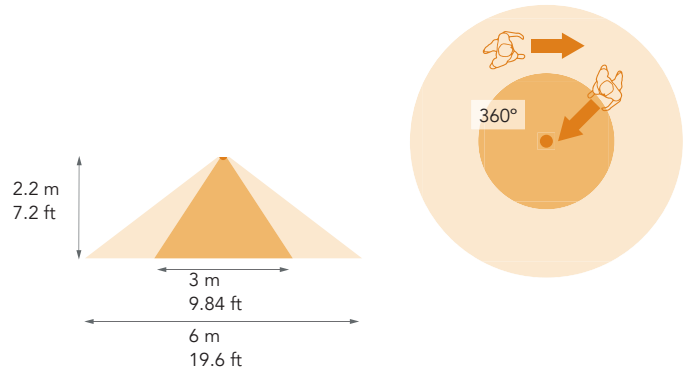

Installation height (h)	Coverage area (Ø)
2.2 m	6 m
3 m	10 m
3.5 m	10 m

FEATURES

Angle of coverage	360°
Area of coverage	6 m (at 2.2 m height)
Adjustment twilight	3 - 2000 lux
Contact capacity	Incandescence: 2000W Energy saving lamps: 1000W LED lamps: 1000W
Supply voltage	220-240VAC 50/60Hz

PACKAGING & LOGISTICS INFORMATION

HS Code: 85365080

Carton box

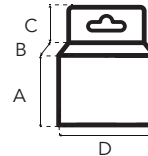

A: 124 mm / 4.88 in
B: 35 mm / 1.38 in
C: 30 mm / 1.18 in
D: 120 mm / 4.72 in
A+C: 154 mm / 6.06 in



Export carton

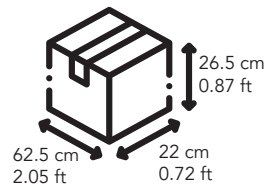

Pallet

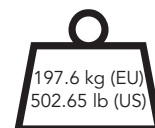
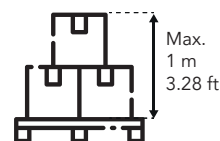

+ 15 kg / 33.06 lb from pallet



- Ceiling mounting presence detector with 3 sensors.
- Large detection area 20m diameter.
- 2000W relay with high switching power.

ZCS TECHNOLOGY
Zero Cross Switching



C-LOGIC 630-MD

Presence detector for large areas and corridors
SKU No : CLOGIC630MD230VCBINT
EAN Code : 8435394748061



More info

CONTENTS



MAIN APPLICATIONS

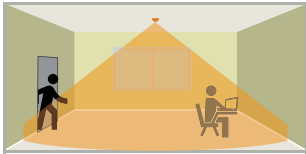

CONNECTION GUIDE

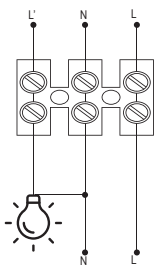

DIMENSIONS

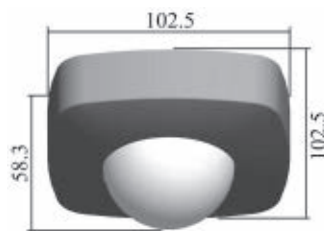

INSTALLATION

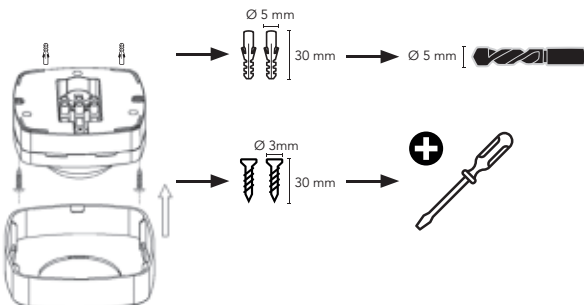

SPECIFICATIONS

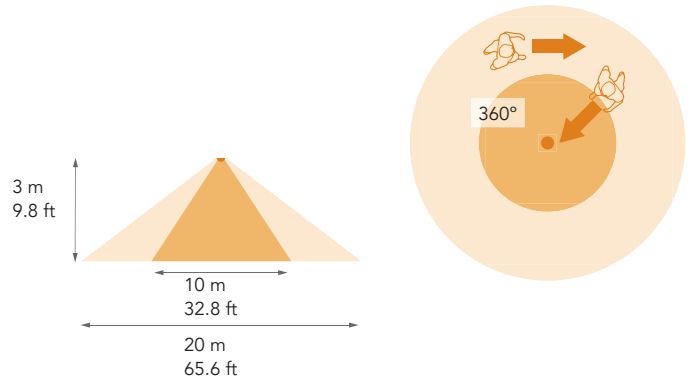

FEATURES

Angle of coverage	360°
Area of coverage	20 m diameter (at 3 m height)
Adjustment twilight	3 - 2000 lux
Contact capacity	Incandescence: 2000W Energy saving lamps: 1000W LED lamps: 1000W
Protection degree	IP65
Supply voltage	220-240VAC 50/60Hz

PACKAGING & LOGISTICS INFORMATION

HS Code: 85365080

Carton box

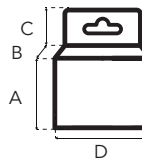

A: 106 mm / 4.17 in
B: 68 mm / 2.68 in
C: 35 mm / 1.38 in
D: 106 mm / 4.17 in
A+C: 141 mm / 5.55 in



Export carton

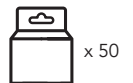
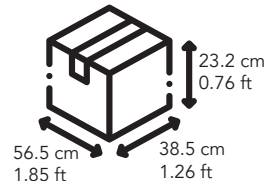

Pallet

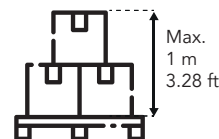

+ 15 kg / 33.06 lb from pallet



- Downlight format for installations in false ceilings.
- 360° Detection coverage.
- Easy and fast to setup up and install.

ZCS TECHNOLOGY
Zero Cross Switching



C-LOGIC 635-MD

False ceiling movement detector
SKU No : CLOGIC635MD230VCBINT
EAN Code : 8435394748078



More info

SPECIFICATIONS

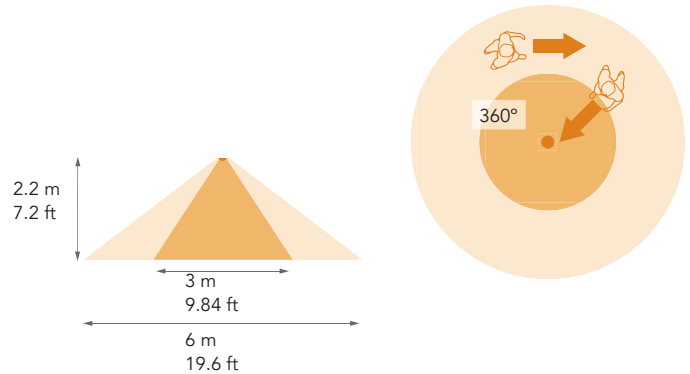

FEATURES

Angle of coverage	360°
Area of coverage	6 m diameter (at 2.2 m height)
Adjustment twilight	3 - 2000 lux
Contact capacity	Incandescence: 1200W Energy saving lamps: 300W LED lamps: 300W
Supply voltage	220-240VAC 50/60Hz

PACKAGING & LOGISTICS INFORMATION

HS Code: 85365080

Carton box

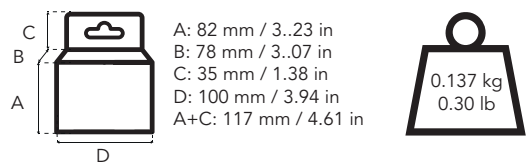

Export carton

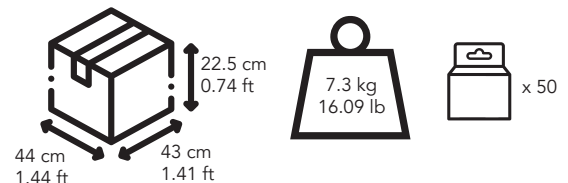

Pallet

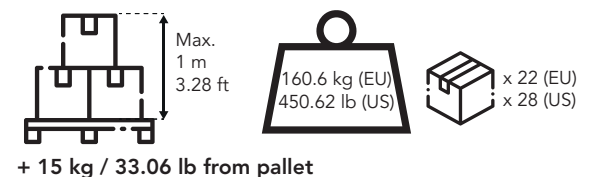

CONTENTS



MAIN APPLICATIONS

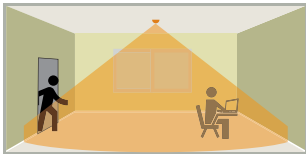

CONNECTION GUIDE

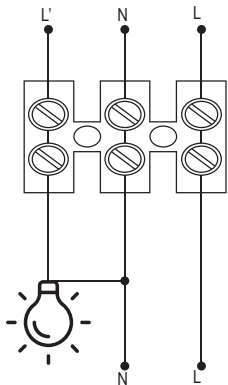

DIMENSIONS

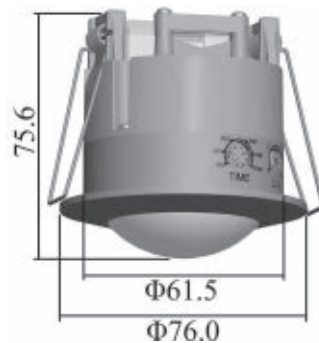

INSTALLATION

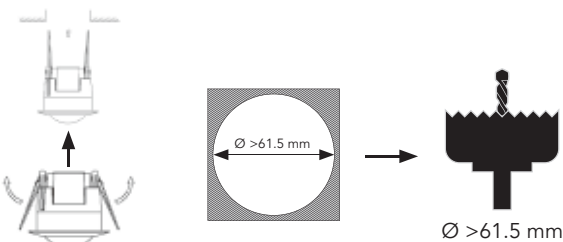

- False ceiling mini movement detector utmost discretion.
- Head of just 5 cm diameter.
- Externally accessible potentiometer behind the external ring.



ZCS TECHNOLOGY
Zero Cross Switching



C-LOGIC 640-MD

False ceiling mini movement detector
SKU No : CLOGIC640MD230VCBINT
EAN Code : 8435394748085



More info

SPECIFICATIONS

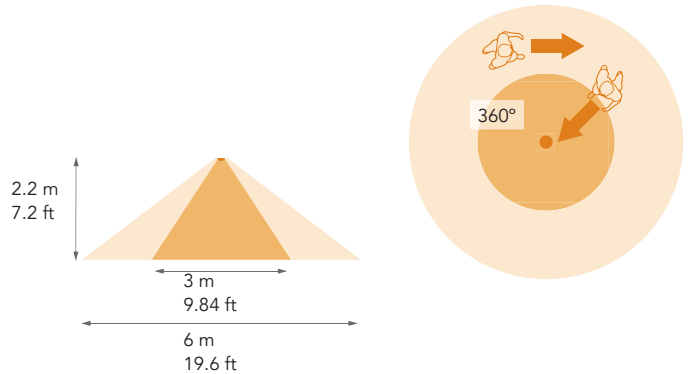

FEATURES

Angle of coverage	360°
Area of coverage	6 m diameter (at 2.2 m height)
Adjustment twilight	3 - 2000 lux
Contact capacity	Incandescence: 800W Energy saving lamps: 400W LED lamps: 400W
Supply voltage	220-240VAC 50/60Hz

PACKAGING & LOGISTICS INFORMATION

HS Code: 85365080

Carton box

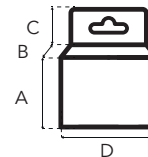

A: 71 mm / 2.80 in
B: 61 mm / 2.40 in
C: 30 mm / 1.18 in
D: 78 mm / 3.07 in
A+C: 101 mm / 3.98 in



Export carton

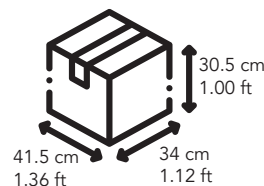

Pallet

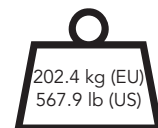
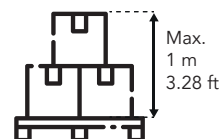

+ 15 kg / 33.06 lb from pallet

CONTENTS



MAIN APPLICATIONS

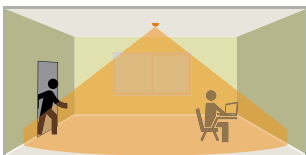

CONNECTION GUIDE

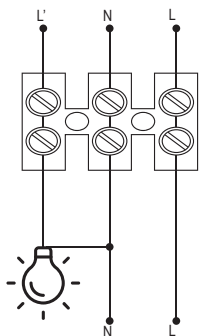

DIMENSIONS

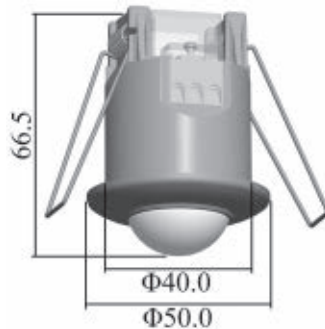

INSTALLATION

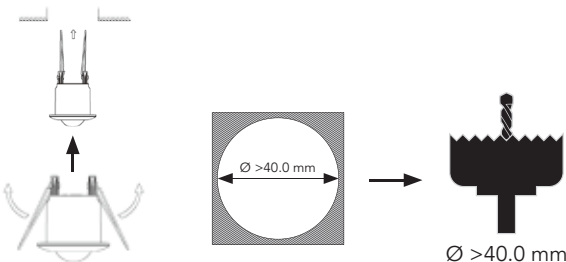



- 2 or 3 wire connection perfect for renovations.
- Manual ON / OFF / AUTO switch.
- The potentiometer and switch remain hidden behind the protective cover to avoid any tampering.

ZCS TECHNOLOGY
Zero Cross Switching



C-LOGIC 645-MD

Movement detector for wiring devices boxes
SKU No : CLOGIC645MD230VCBINT
EAN Code : 8435394748115



More info

CONTENTS



MAIN APPLICATIONS

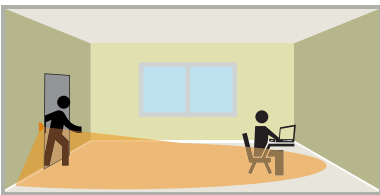

CONNECTION GUIDE

2 wires

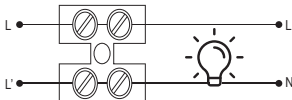

3 wires

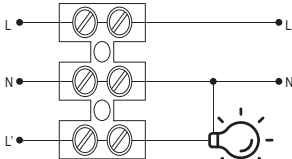

DIMENSIONS

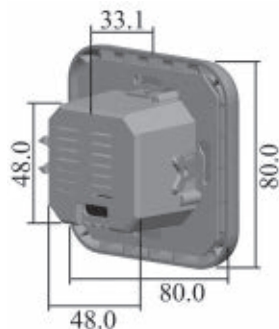

INSTALLATION

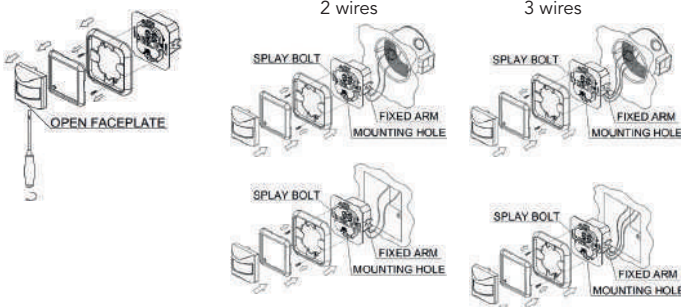

SPECIFICATIONS

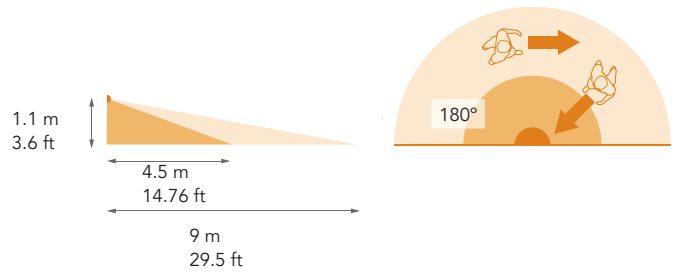

FEATURES

Angle of coverage	180°
Area of coverage	9 m diameter (at 1.1 m height)
Adjustment twilight	3 - 2000 lux
Contact capacity	Incandescence: 500W Energy saving lamps: 200W LED lamps: 200W
Minimum power required	5W to 2 wires
Supply voltage	220-240VAC 50/60Hz

PACKAGING & LOGISTICS INFORMATION

HS Code: 85365080

Carton box

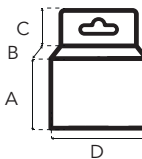

A: 85 mm / 3.35 in
B: 71 mm / 2.80 in
C: 35 mm / 1.38 in
D: 83 mm / 3.27 in
A+C: 120 mm / 4.72 in



Export carton

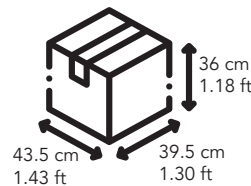

Pallet

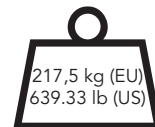
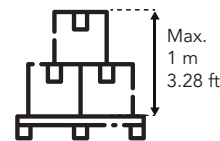

+ 15 kg / 33.06 lb from pallet



- It detects through surfaces allowing you to install the product above false ceilings remaining hidden
- 5.8 GHz high frequency technology
- Great coverage of up to 16 m in diameter (adjustable from 2 to 16m).



C-LOGIC 650-MD

Movement detector hidden in false ceiling
 SKU No : CLOGIC650MD230VCBINT
 EAN Code : 8435394748108



More info

SPECIFICATIONS

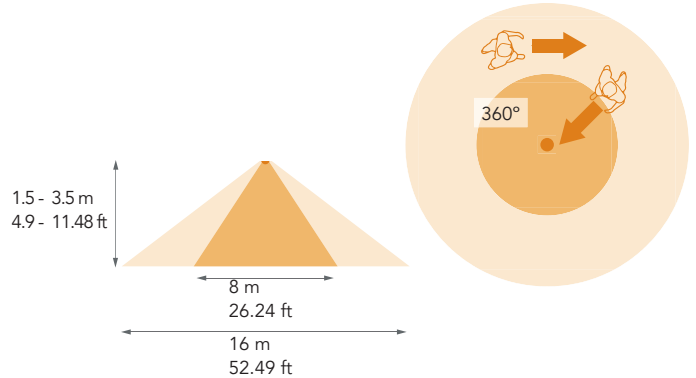

FEATURES

Angle of coverage	360°
Area of coverage	16 m diameter (at 2.2m height)
Adjustment twilight	3 - 2000 lux
Contact capacity	Incandescence: 1200W Energy saving lamps: 300W LED lamps: 300W
Supply voltage	220-240VAC 50/60Hz

PACKAGING & LOGISTICS INFORMATION

HS Code: 85311030

Carton box

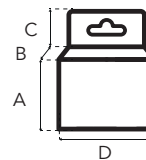

A: 74 mm / 2.91 in
 B: 50 mm / 1.97 in
 C: 30 mm / 1.18 in
 D: 51 mm / 2.01 in
 A+C: 104 mm / 4.09 in



Export carton

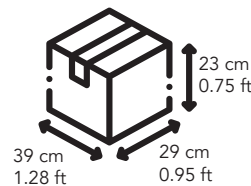

Pallet

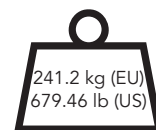
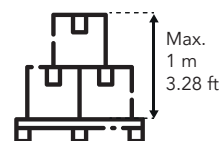

+ 15 kg / 33.06 lb from pallet

CONTENTS



MAIN APPLICATIONS

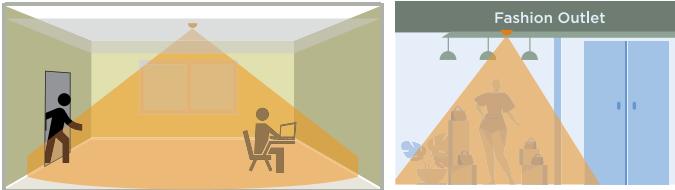

CONNECTION GUIDE

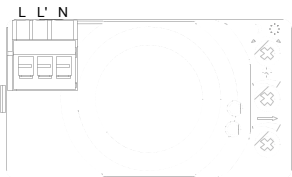

Connect . L with power; Connect . L' with load.

DIMENSIONS

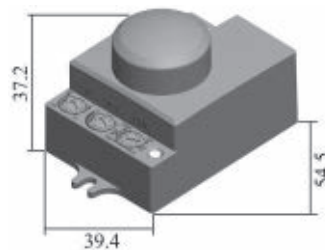

INSTALLATION

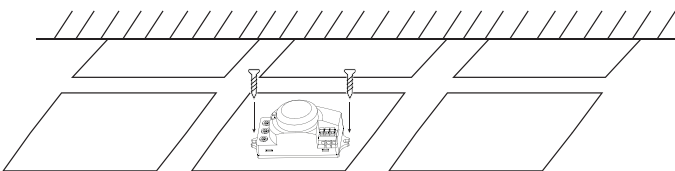



- 360° coverage area.
- Max. range 6m diameter.
- Twilight adjustment: 3 to 2.000 lux.
- Time adjustment: 10 seconds to 5 minutes.
- Maximum contact capacity: 60W (E27).

C-LOGIC 655-MD

Lampholder with integrated detector
 SKU No : CLOGIC655MD230VCBINT
 EAN Code : 8435394777559
 UPC Code : 810053671870



SPECIFICATIONS

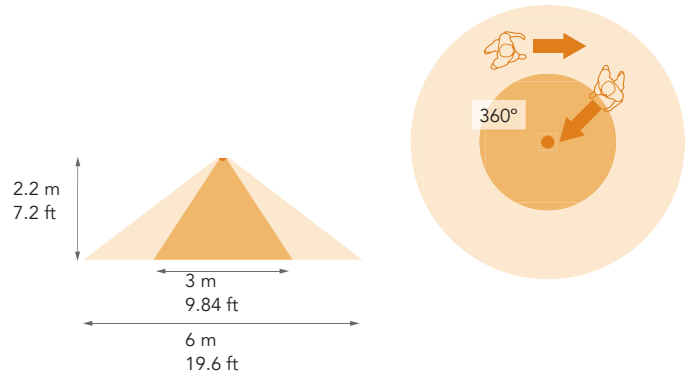

FEATURES

Angle of coverage	360°
Area of coverage	6 m diameter
Adjustment twilight	3 - 2000 lux
Contact capacity	Incandescence: 60W Energy saving lamps: 60W LED lamps: 60W
Supply voltage	110-240V. 50Hz

PACKAGING & LOGISTICS INFORMATION

HS Code: 85414080

Carton box

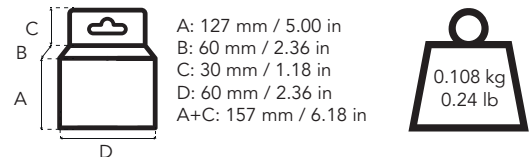

Export carton

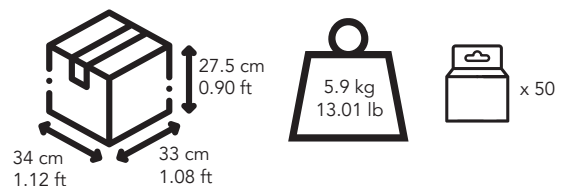

Pallet

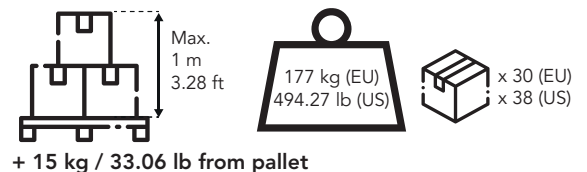

CONTENTS



MAIN APPLICATIONS

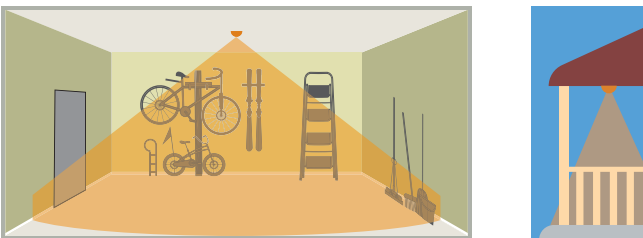

CONNECTION GUIDE



DIMENSIONS

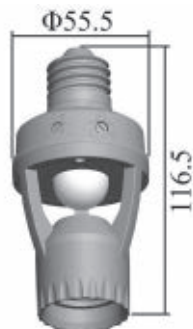

- False ceiling micro movement detector head of just 2 cm diameter.
- For installation in false ceilings interior of closet, etc.
- Time and lux adjustment.



C-LOGIC 660-MD

Surface / pole twilight detector
 SKU No : CLOGIC660MD230VCBINT
 EAN Code : 8435394748092



More info

SPECIFICATIONS

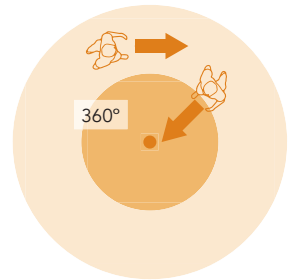
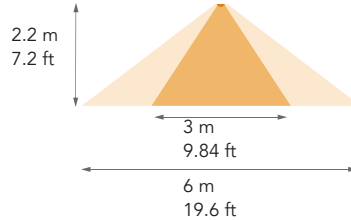

FEATURES

Angle of coverage	Ceiling: 360° Wall: 120°
Area of coverage	Ceiling: 6 m diameter (at 2.2 m height) Wall: 8 m
Adjustment twilight	3 - 2000 lux
Contact capacity	Incandescence: 800W Energy saving lamps: 200W LED lamps: 200W
Supply voltage	220-240VAC 50-60Hz

PACKAGING & LOGISTICS INFORMATION

HS Code: 85365080

Carton box

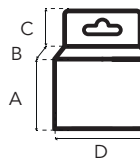

A: 88 mm / 3.46 in
 B: 48 mm / 1.89 in
 C: 30 mm / 1.18 in
 D: 48 mm / 1.89 in
 A+C: 118 mm / 4.65 in



Export carton

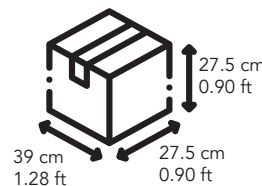

Pallet

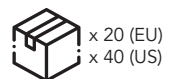
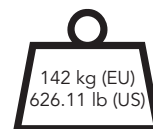
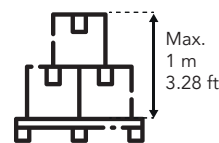

+ 15 kg / 33.06 lb from pallet

CONTENTS

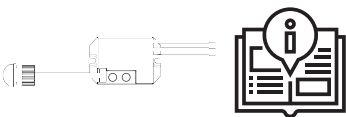

MAIN APPLICATIONS

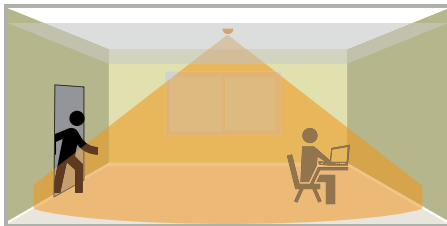

CONNECTION GUIDE

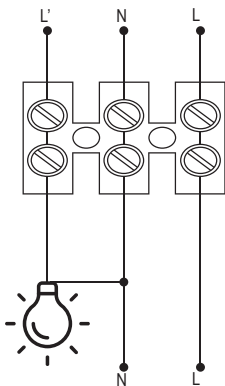

DIMENSIONS

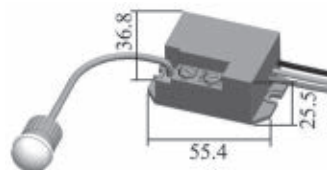

INSTALLATION

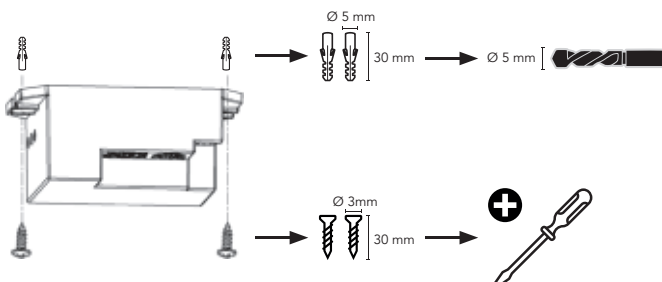



- Supply: 1 x 9V battery (included)
- 60° coverage area
- Max. range of 8 m
- Alarm sound: ≥ 70 dB
- 3 positions:
 - Chime: ring function
 - Alarm
 - OFF



C-LOGIC 600-MD

Mini sensor alarm with integrated presence detector
 SKU No : CLOGIC600MDCBINT
 EAN Code : 8435394748139
 UPC Code : 810053671313



More info

SPECIFICATIONS

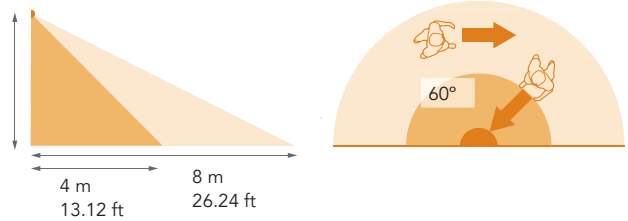

FEATURES

Angle of coverage	60°
Max. area of coverage	8 m
Sound level	≥ 70 dB
Supply voltage	1 x 9V battery included

PACKAGING & LOGISTICS INFORMATION

HS Code: 85365080

Carton box

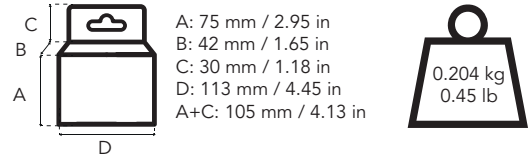

Export carton

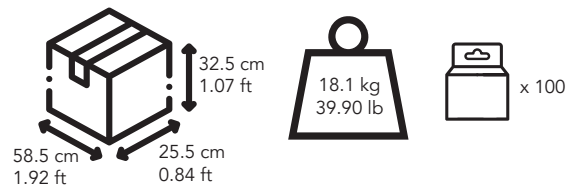

Pallet

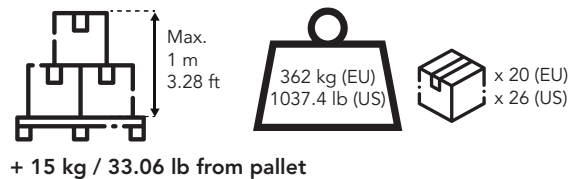

CONTENTS



MAIN APPLICATIONS

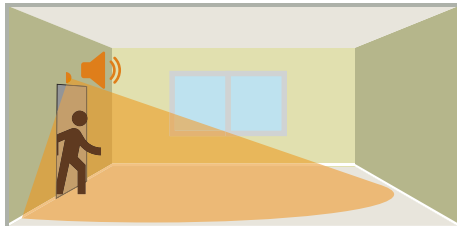

CONNECTION GUIDE

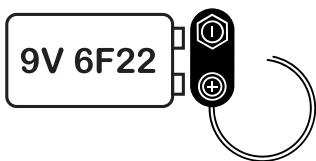



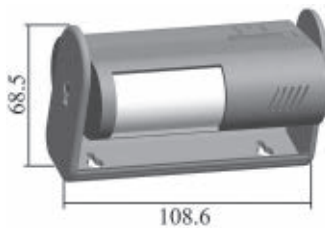



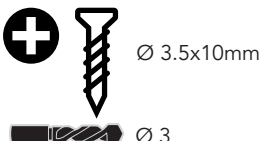
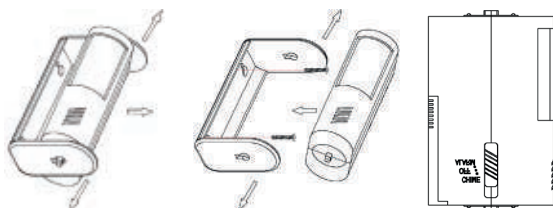

DIMENSIONS



INSTALLATION



FUNCTIONS						
	C-LOGIC 610-MD	C-LOGIC 615-MD	C-LOGIC 620-MD	C-LOGIC 630-MD	C-LOGIC 635-MD	C-LOGIC 640-MD
SKU NO.	CLOGIC610MD 230VCBINT	CLOGIC615MD 230VCBINT	CLOGIC620MD 230VCBINT	CLOGIC630MD 230VCBINT	CLOGIC635MD 230VCBINT	CLOGIC640MD 230VCBINT
Mounting	Wall	Wall	Ceiling	Ceiling	Flush Mounting	Flush Mounting
Power supply	220 - 240VAC, 50/60Hz	220 - 240VAC, 50/60Hz	220 - 240VAC, 50/60Hz	220 - 240VAC, 50/60Hz	220 - 240VAC, 50/60Hz	220 - 240VAC, 50/60Hz
Connection system	3 Wires	3 Wires	3 Wires	3 Wires	3 Wires	3 Wires
Technology	Infrared	Infrared	Infrared	Infrared	Infrared	Infrared
Angle of Coverage	180°	180°	360°	360°	360°	360°
Area of Coverage	12m (at 2,5m)	12m (at 2,5m)	6m (at 2,2m)	20 m (at 3m)	6m (at 2,2m)	6 m (at 2,2m)
Mounting height	1,8 - 2,5m	1,8 - 2,5m	2,2 - 4m	2,2 - 6m	2,2 - 4m	1,8 - 2,5m
Time adjustments	10sec - 15min	10sec - 15min	10sec - 7min	10sec - 12min	10sec - 15min	10sec - 15min
Adjustment twilight	3 - 2.000lux	3 - 2.000lux	3 - 2.000lux	3 - 2.000lux	3 - 2.000lux	3 - 2.000lux
Realy Technology	Zero Cross Switching	Zero Cross Switching	Standard	Zero Cross Switching	Zero Cross Switching	Zero Cross Switching
IP degree	IP44	IP65	IP20	IP65	IP20	IP20
Contact capability	Incandescent: 800W Energy saving & LED: 400W	Incandescent: 1.200W Energy saving & LED: 300W	Incandescent: 1.200W Energy saving & LED: 300W	Incandescent: 2000W Energy saving & LED: 1000W	Incandescent: 1.200W Energy saving & LED: 300W	Incandescent: 800W Energy saving & LED: 400W

FUNCTIONS			
	C-LOGIC 660-MD	C-LOGIC 650-MD	C-LOGIC 645-MD
SKU NO.	CLOGIC660MD 230VCBINT	CLOGIC650MD 230VCBINT	CLOGIC645MD 230VCBINT
Mounting	Flush Mounting	False Ceiling	Box
Power supply	220 - 240VAC, 50Hz	220 - 240VAC, 50/60Hz	220 - 240VAC, 50Hz
Connection system	3 Wires	3 Wires	2 and 3 Wires
Technology	Infrared	MW 5.8GHz	Infrared
Angle of Coverage	360°	360°	180°
Area of Coverage	6m (at 2,2m)	16m (at 2,2m)	9m (at 1,1m)
Mounting height	2,2 - 4m	2,2 - 4m	1 - 1,8m
Time adjustments	10sec - 8min	10sec - 12min	10sec - 7min
Adjustment twilight	3 - 2.000lux	3 - 2.000lux	3 - 2.000lux
Realy Technology	Standard	Standard	Standard
IP degree	IP20	IP20	IP20
Contact capability	Incandescent: 800W Energy saving & LED: 200W	Incandescent: 1.200W Energy saving & LED: 300W	Incandescent: 500W Energy saving & LED: 200W



- 2 Lamp holders E27 suitable for all types of lamps.
- Glass lampshade white aluminium base Polycarbonate lampshade.
- The wide curvature of the dome light allows the installation of large lamps.

C-LOGIC 670-MD

PIR sensor light with built-in LED
 SKU No : CLOGIC670MD230VCBINT
 EAN Code : 8435394776996



More info

SPECIFICATIONS

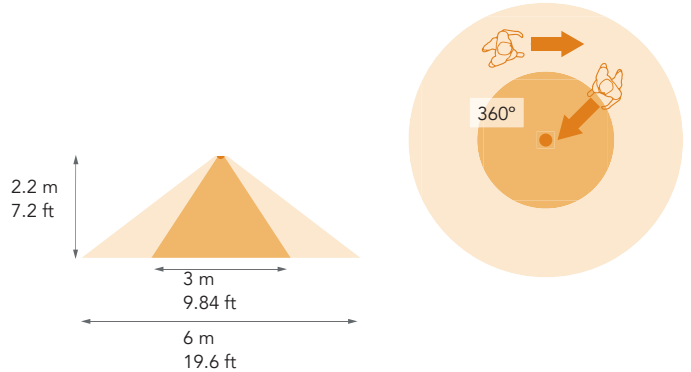

220-240~50/60Hz	3-2000 Lux	10s - 3min	IP 20	OK LED
-----------------	------------	------------	-------	--------

FEATURES

Angle of coverage	360°
Area of coverage	6 m diameter (at 2.2 m height)
Adjustment twilight	3 - 2000 lux
Contact capacity	2x40W
Supply voltage	110-240VAC 50/60Hz

PACKAGING & LOGISTICS INFORMATION

HS Code: 94051098

Carton box

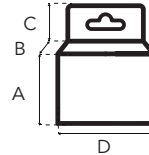

A: 303 mm / 11.93 in
 B: 97 mm / 3.82 in
 C: 0 mm / 0 in
 D: 305 mm / 12.01 in
 A+C: 303 mm / 11.93 in



Export carton

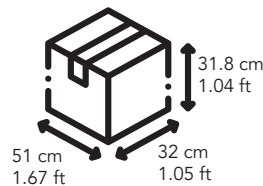

Pallet

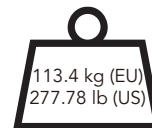
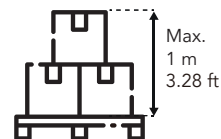

+ 15 kg / 33.06 lb from pallet

CONTENTS



MAIN APPLICATIONS

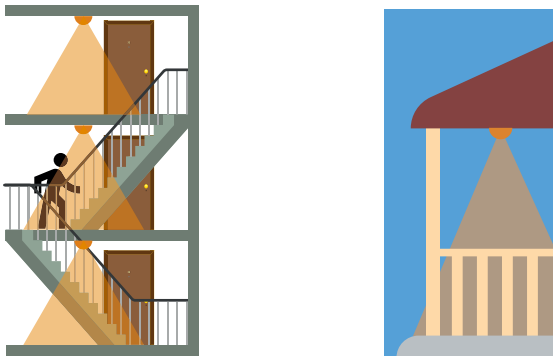

CONNECTION GUIDE

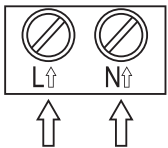

DIMENSIONS



INSTALLATION

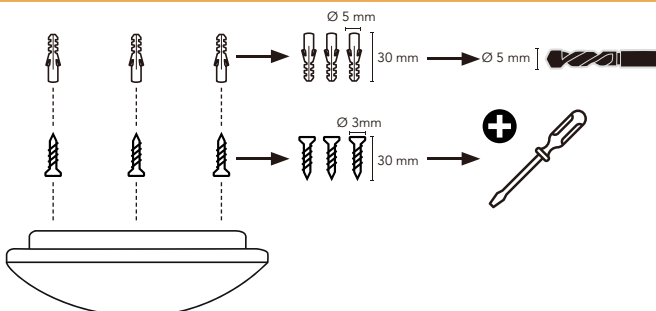



- High Frequency PIR detection with built-in LED board
- Plastic lampshade white aluminium base
- 16W integrated LED
- Luminous flux of 1.100 lumens
- Color temperature: 4.000K

C-LOGIC 680-MD

PIR sensor light with built-in LED
 SKU No : CLOGIC680MDDUALCBINT
 EAN Code : 8435394777016
 UPC Code : 810053671610

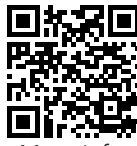

More info

CONTENTS

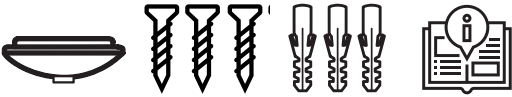

MAIN APPLICATIONS



CONNECTION GUIDE

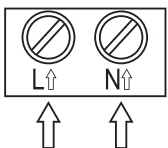

DIMENSIONS



INSTALLATION

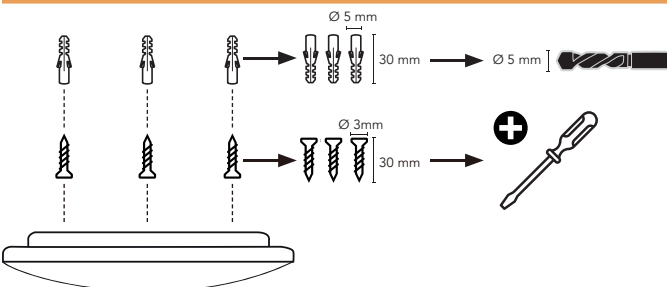

SPECIFICATIONS

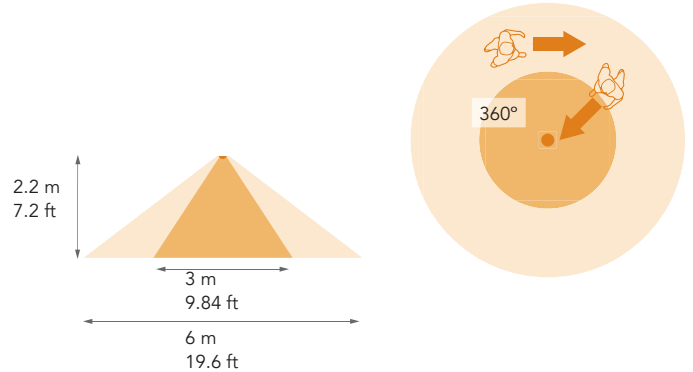

110-240~50/60Hz	3-2000 Lux	10s - 3min	IP 20	OK LED
-----------------	------------	------------	-------	--------

FEATURES

Angle of coverage	360°
Area of coverage	6 m diameter (at 2.2 m height)
Adjustment twilight	3 - 2000 lux
Contact capacity	16W built-in LED. 1100 lumens. 4000K
Supply voltage	110-240VAC 50/60Hz

PACKAGING & LOGISTICS INFORMATION

HS Code: 94051098

Carton box

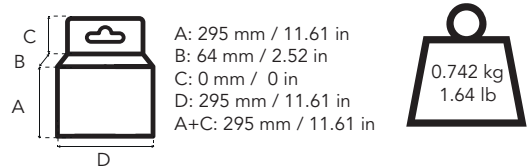

Export carton

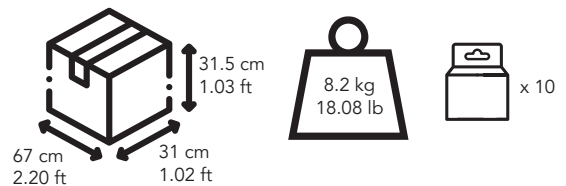

Pallet

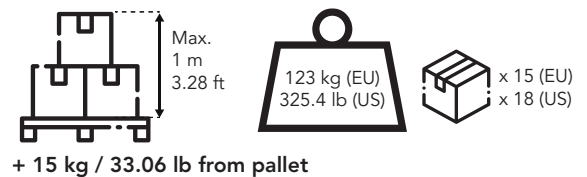



- PIR technology with integrated LED.
- Material:PC(UV proof)

ZCS TECHNOLOGY
Zero Cross Switching



More info

C-LOGIC 685-MD

PIR sensor light with built-in LED
SKU No : CLOGIC685MDDUALCBINT
EAN Code : 8435394777023
UPC Code : 810053671627

CONTENTS



MAIN APPLICATIONS

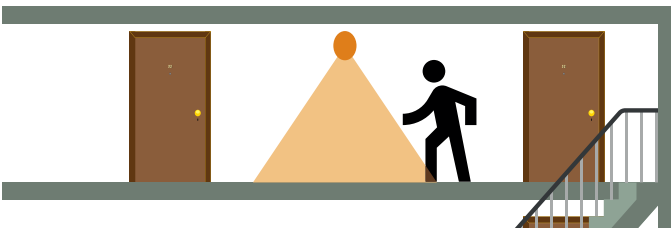

CONNECTION GUIDE

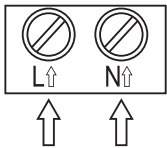

DIMENSIONS



INSTALLATION

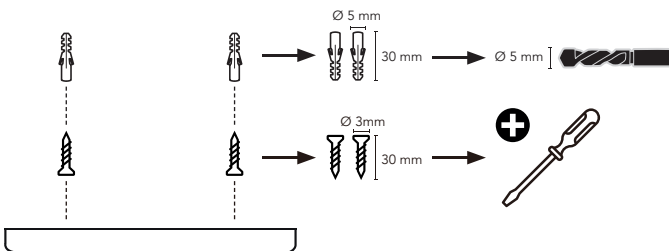

SPECIFICATIONS

Wall installation

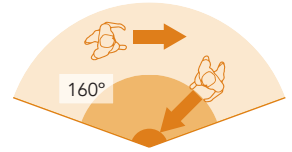
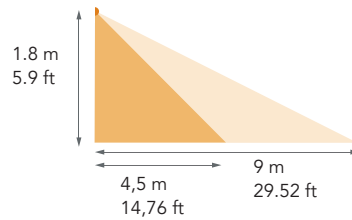

Ceiling installation

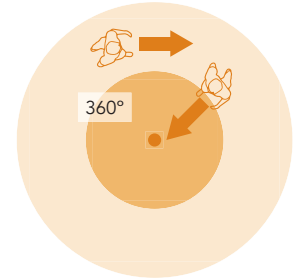
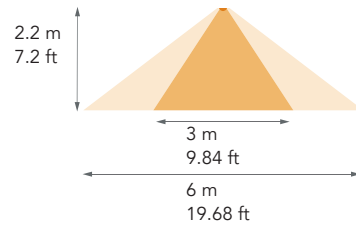



FEATURES

Angle of coverage	160° (wall) - 360°(ceiling)
Area of coverage	9 m (wall) - 6 m (ceiling)
Adjustment twilight	3 - 2000 lux
Rated Load	15W
Supply voltage	110-240V; 50-60Hz

PACKAGING & LOGISTICS INFORMATION

HS Code: 94051098

Check available packaging options.

FUNCTIONS			
	C-LOGIC 670-MD	C-LOGIC 680-MD	C-LOGIC 685-MD
SKU NO.	CLOGIC670MD 230VCBINT	CLOGIC680MD DUALCBINT	CLOGIC685MD DUALCBINT
Power supply	230VAC, 50/60Hz	110 - 240VAC, 50/60Hz	110 - 240VAC, 50/60Hz
Connection system	2 Wires	2 Wires	2 Wires
Technology	Infrared	Infrared	Infrared
Angle of Coverage	360°	360°	Wall: 160°
Area of Coverage	6 m (at 2,2m)	6 m (at 2,2m)	9 m (at 2.2 m)
Mounting height	2,2 - 4m	2,2 - 4m	1,8 - 4m
Time adjustments	10sec - 3min	10sec - 3min	10sec - 5min
Adjustment twilight	3 - 2.000lux	3 - 2.000 lux	3 - 2.000lux
Lamp	2 lampholder E27 up to 40W	LED plate 16W, 1.100 lumens, 4.000k	Placa LED 15W, 1.300 lúmens, 4.000K
Base Material	White Aluminium	White Aluminium	White Aluminium
Dome Material	Glass	Plastic (Polycarbonate)	Plastic (Polycarbonate)
IP degree	IP20	IP20	IP44



- For wall mounting.
- Suitable for outdoor applications.
- Twilight setting from 2 to 100 lux.
- Security timing of 1 min in on and off to prevent false switching

C-LOGIC 515-PC

Wall twilight switch IP44
 SKU No : CLOGIC515PC230VCBINT
 EAN Code : 8435394777030



More info

SPECIFICATIONS



FEATURES

Security timing of 1 min in on and off to prevent falseswitching

Adjustment LED

According to EN 60669-1:1999+A1:2002+A2:200.
 EN 60669-2-1:2004+A1:2009+A12:2010

PACKAGING & LOGISTICS INFORMATION

HS Code: 85311030

Carton box

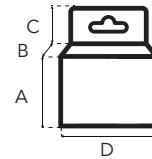

A: 105 mm / 4.13 in
 B: 43 mm / 1.69 in
 C: 30 mm / 1.18 in
 D: 72 mm / 2.83 in
 A+C: 135 mm / 5.31 in



Export carton

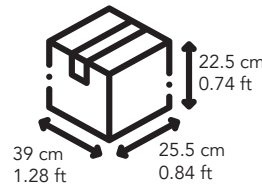

x 50

Pallet

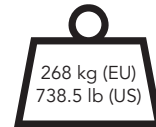
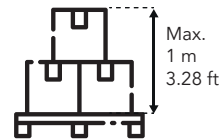

x 40 (EU)
 x 50 (US)

+ 15 kg / 33.06 lb from pallet

CONTENTS



MAIN APPLICATIONS

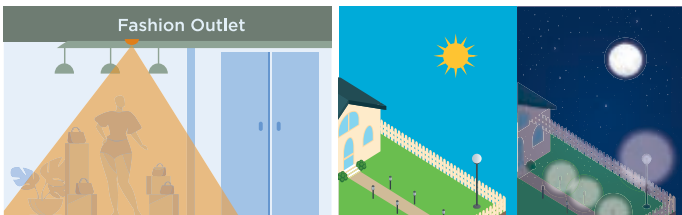

CONNECTION GUIDE

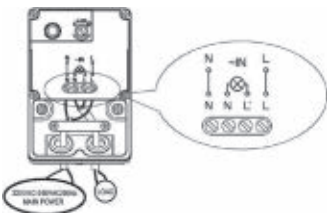

DIMENSIONS



INSTALLATION

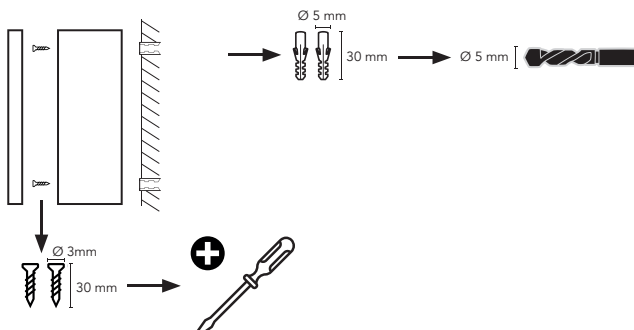



- For wall mounting.
- Suitable for outdoor applications.
- Twilight setting from 3 to 500 lux.
- Security timing of 1 min in on and off to prevent false switching

C-LOGIC 510-PC

Wall twilight switch IP54
 SKU No : CLOGIC510PC230VCBINT
 EAN Code : 8435394748122



More info

CONTENTS



MAIN APPLICATIONS

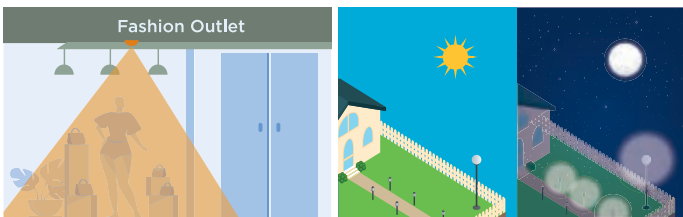

CONNECTION GUIDE

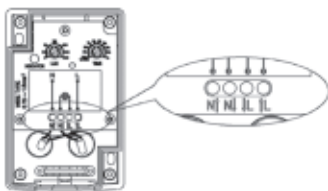

DIMENSIONS



INSTALLATION

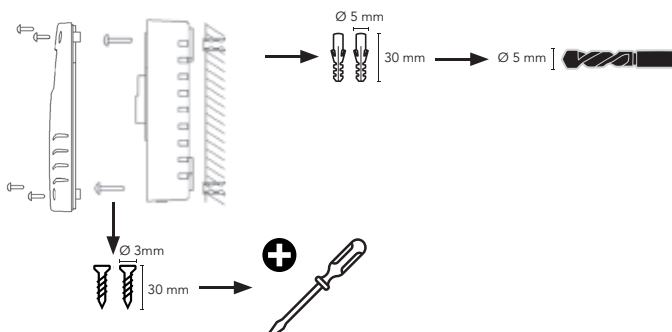

SPECIFICATIONS



FEATURES

Security timing of 1 min in on and off to prevent false switching

Adjustment LED

Optional switching OFF timing for 1 to 9 hours from the moment it is activated

According to EN 60669-1:1999+A1:2002+A2:200.
 EN 60669-2-1:2004+A1:2009+A12:2010

PACKAGING & LOGISTICS INFORMATION

HS Code: 85311030

Carton box

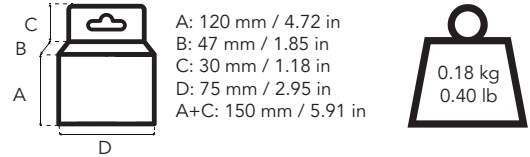

Export carton

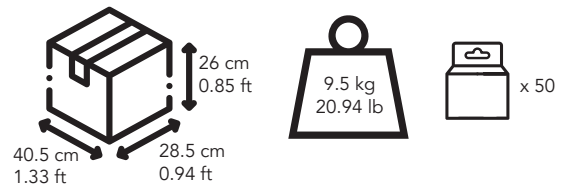

Pallet

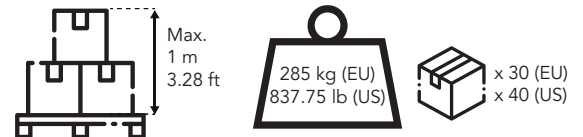

+ 15 kg / 33.06 lb from pallet



- Twist and lock NEMA standard
- MOV built-in for lightning protection
- Time delay to avoid false switchings
- Fail ON or fail OFF modes



C-LOGIC 500-PC

Mechanical photocell
 SKU No : CLOGIC500PC230VCBINT
 EAN Code : 8435394776774
 UPC Code : 810053670934



More info

SPECIFICATIONS



FEATURES

Rated Voltage	220-240V~, 50/60Hz
Rated Loading	1800W Tungsten, 1000VA Ballast
Power consumption	1.5VA (average)
Delay Time	30 sec.

GENERAL

Surge arrester	•
Ambient Temperature	-40°C/70°C (-40°F/158°F)
Related Humidity	99%
Protection degree	IP54
Certifications	UL

PACKAGING & LOGISTICS INFORMATION

HS Code: 85414001

Check available packaging options.

CONTENTS



MAIN APPLICATIONS

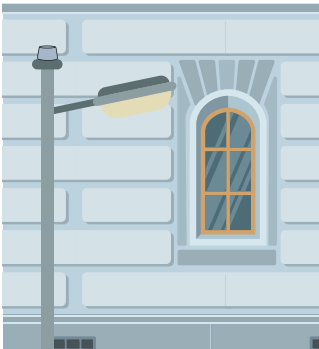

CONNECTION GUIDE

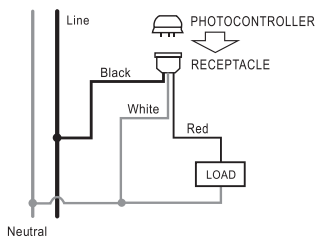

DIMENSIONS

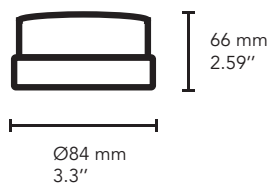

INSTALLATION

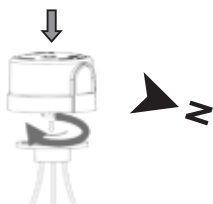



- Twist and lock NEMA standard
- MOV built-in for lightning protection
- Time delay to avoid false switchings
- Fail ON or fail OFF modes



C-LOGIC 501-PC

Electronic photocell
 SKU No : CLOGIC501PCDUALCBINT
 EAN Code : 8435394776781
 UPC Code : 810053670958

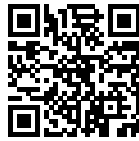

More info

SPECIFICATIONS



FEATURES

Rated Voltage	120-277V~,50/60Hz
Rated Loading	1000W Tungsten, 1800VA Ballast
Power consumption	1.5VA (average)
Delay Time	30 sec.

GENERAL

Surge arrester	•
Ambient Temperature	-40°C/70°C (-40°F/158°F)
Related Humidity	99%
Protection degree	IP54
Certifications	UL

PACKAGING & LOGISTICS INFORMATION

HS Code: 85414001

Check available packaging options.

CONTENTS



MAIN APPLICATIONS

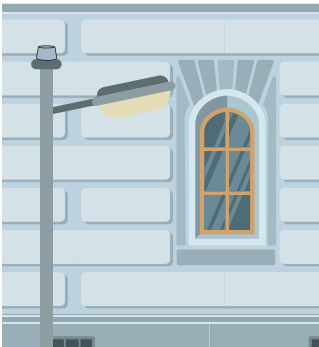

CONNECTION GUIDE

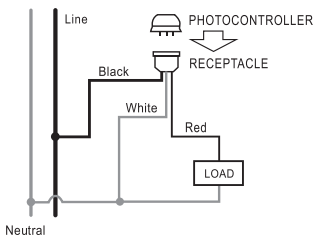

DIMENSIONS

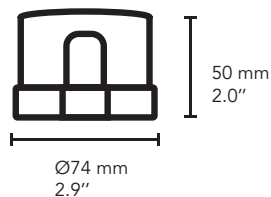

INSTALLATION

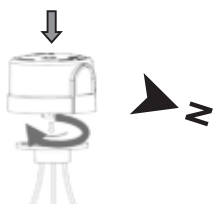



- Twist and lock NEMA standard
- Designed to fit ANSI C136.10-1996 twist-lock photocontrol



C-LOGIC 502-PC

Photocell base
 SKU No : CLOGIC502PC480VCBINT
 EAN Code : 8435394776798
 UPC Code : 810053670972



More info

SPECIFICATIONS



FEATURES

Rated Voltage	480V~,50/60Hz
Loading capacity	15Amp Maz.

GENERAL

Ambient Temperature	-40°C/70°C (-40°F/158°F)
Related Humidity	99%
Receptacle material	Bakelite
Contact material	Brass
Gasket	Silicon rubber
Certifications	UL

PACKAGING & LOGISTICS INFORMATION

HS Code: 85414019

Check available packaging options.

CONTENTS



MAIN APPLICATIONS

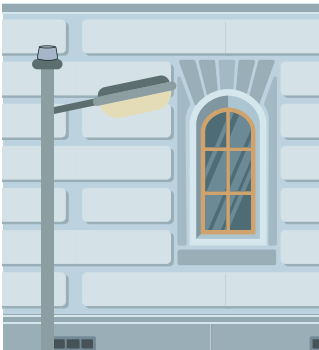

CONNECTION GUIDE

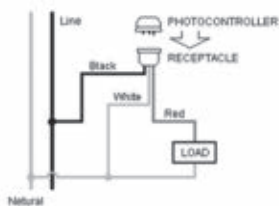

DIMENSIONS

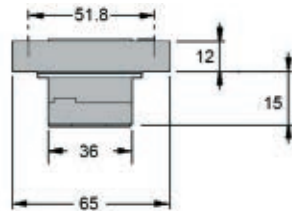

INSTALLATION

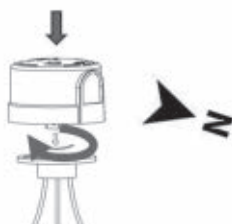



- Suitable for Surface/pole mounting
- Rated loading: 20 Amps



C-LOGIC 520-PC

Electromechanical Photocontroller
 SKU No : CLOGIC520PC230VCBINT
 EAN Code : 8435394777047



More info

SPECIFICATIONS



FEATURES

Rated Voltage	220-240V~ ,50/60Hz
Rated Loading	20A
Power consumption	1.5VA (average)
Lux control	<5-50Lux (adjustable)

GENERAL

Ambient Temperature	20°C/+40°C
Related Humidity	93%
Protection degree	IP44
Certifications	CE,ROHS

PACKAGING & LOGISTICS INFORMATION

HS Code: 85318040

Check available packaging options.

CONTENTS



MAIN APPLICATIONS

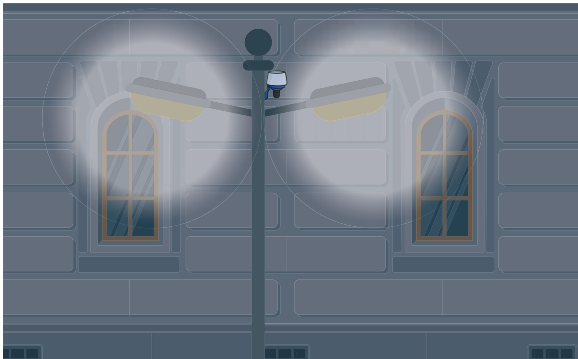

CONNECTION GUIDE

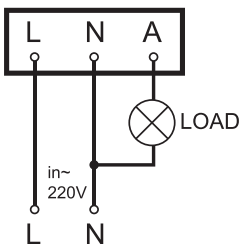

DIMENSIONS

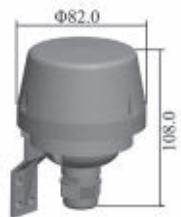

INSTALLATION

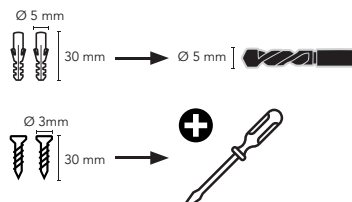



- Electromechanical buzzer
- Power supply: 230VAC 50-60Hz
- 2-wire connection
- Compact size
- Installation using 1 fixing screw
- High sound level

C-LOGIC 800-DC

Electromechanical buzzer
 SKU No : CLOGIC800DC230VCBINT
 EAN Code : 8435394777054



More info

SPECIFICATIONS



FEATURES

According to EN 62080:2009

Power supply: 230VAC 50-60Hz

2-wire connection

Compact size

Installation using 1 fixing screw

High sound level

PACKAGING & LOGISTICS INFORMATION

HS Code: 85318040

Carton box

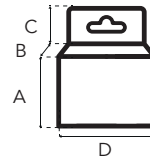

A: 60 mm / 2.36 in
 B: 40 mm / 1.57 in
 C: 0 mm / 0 in
 D: 40 mm / 1.57 in
 A+C: 60 mm / 2.36 in



Export carton

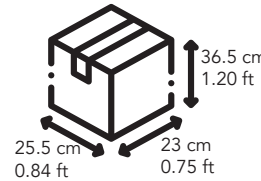

Pallet

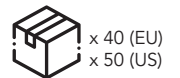
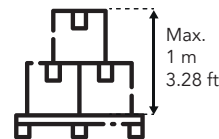

+ 15 kg / 33.06 lb from pallet

CONTENTS

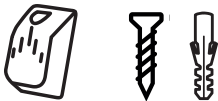

MAIN APPLICATIONS

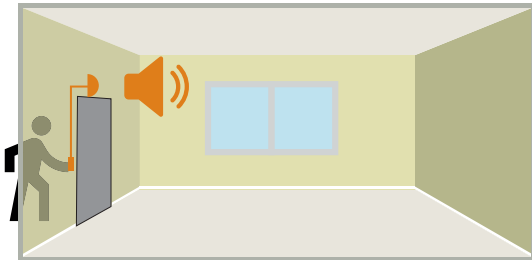

CONNECTION GUIDE

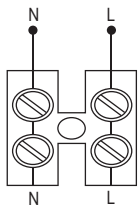

DIMENSIONS

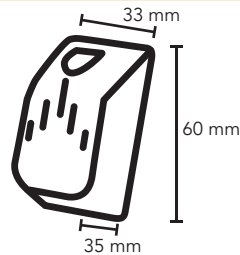

INSTALLATION

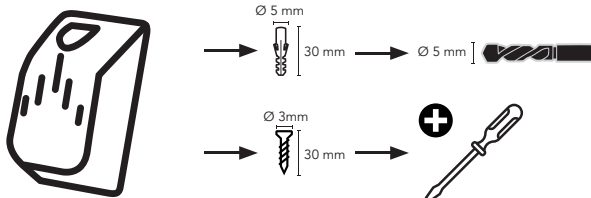



- Electromechanical ding-dong doorbell
- Power supply: 230VAC 50-60Hz
- 2-wire connection
- 10.000 turn coil that gives it a long service life
- High power and pleasant sound for home environments

C-LOGIC 810-DC

Electromechanical ding-dong doorbell
 SKU No : CLOGIC810DC230VCBINT
 EAN Code : 8435394777061

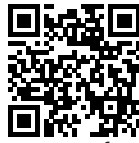

More info

SPECIFICATIONS



FEATURES

According to EN 62080:2009

Suitable for indoor use

PACKAGING & LOGISTICS INFORMATION

HS Code: 85318040

Carton box

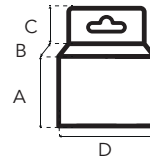

A: 140 mm / 5.51 in
 B: 50 mm / 1.97 in
 C: 45 mm / 1.77 in
 D: 85 mm / 3.35 in
 A+C: 185 mm / 7.28 in



Export carton

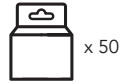
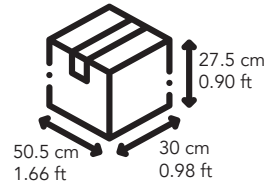

Pallet

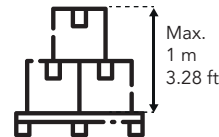

+ 15 kg / 33.06 lb from pallet

CONTENTS



MAIN APPLICATIONS

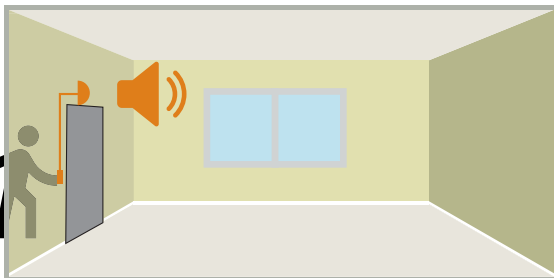

CONNECTION GUIDE

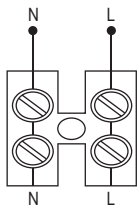

DIMENSIONS

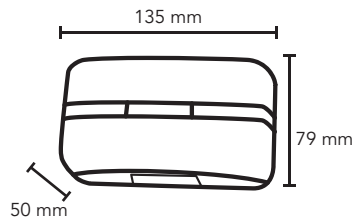

INSTALLATION

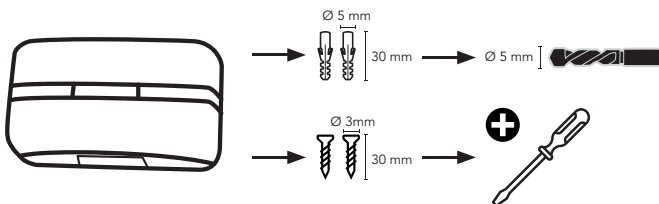



- Electronic operation
- 16 chime melodies
- Reach range of 80m between the transmitter and receiver
- Light indicator when the bell is sounding
- Transmitter with label holder

C-LOGIC 830-DC

Wireless electronic doorbell
 SKU No : CLOGIC830DCCBINT
 EAN Code : 8435394777078
 UPC Code : 810053671634



More info

SPECIFICATIONS



FEATURES

Possibility of personalization in the switch

Suitable for indoor use

According to EN 62080:2009

Power supply: 3x1.5AA included, 1xLR2312V included

PACKAGING & LOGISTICS INFORMATION

HS Code: 85318040

Carton box

A: 125 mm / 4.92 in
 B: 40 mm / 1.57 in
 C: 0 mm / 0 in
 D: 125 mm / 4.92 in
 A+C: 125 mm / 4.92 in

0.22 kg / 0.49 lb

Export carton

28 cm / 0.92 ft
 42.5 cm / 1.39 ft
 26.5 cm / 0.87 ft

7.5 kg / 16.53 lb

x 40

Pallet

Max. 1 m / 3.28 ft

135 kg (EU) / 396.83 lb (US)

x 18 (EU) / x 24 (US)

+ 15 kg / 33.06 lb from pallet

CONTENTS

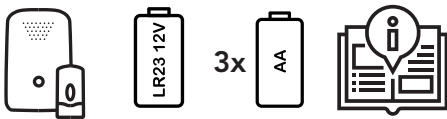

MAIN APPLICATIONS

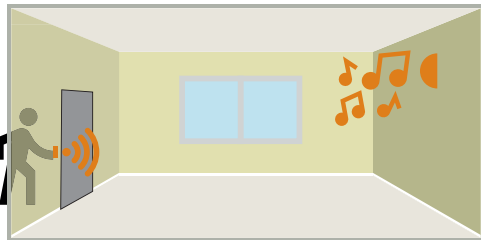

CONNECTION GUIDE

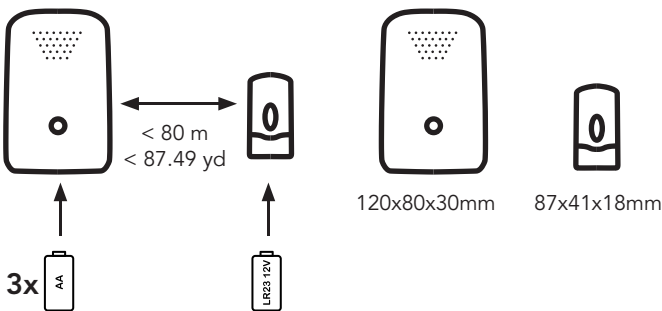

DIMENSIONS

INSTALLATION

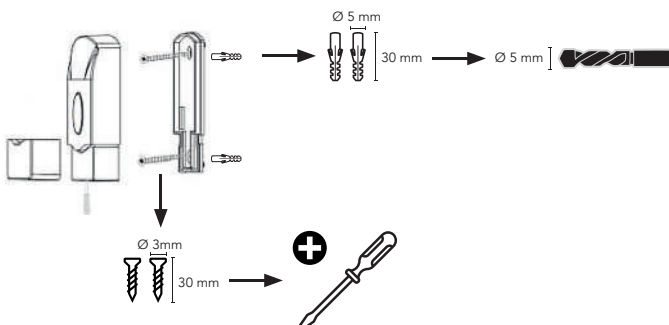



- Electronic operation
- 36 chime melodies
- Reach range of 150m between the transmitter and receiver
- Light indicator when the bell is sounding
- Transmitter with label holder
- Plug-in type

C-LOGIC 840G-DC

Wireless electronic doorbell
 SKU No : CLOGIC840GDC230VCBINT
 EAN Code : 8435394777085



More info

SPECIFICATIONS



FEATURES

- Suitable for indoor use
- Possibility of personalization in the switch
- Possibility of connecting up to 5 switches to the same bell
- According to EN 62080:2009
- Power supply: 1xCR2032 included

PACKAGING & LOGISTICS INFORMATION

HS Code: 85318040

Carton box

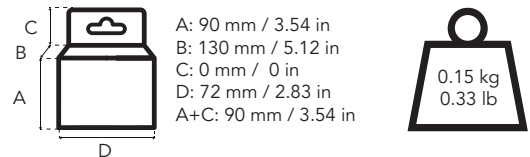

Export carton

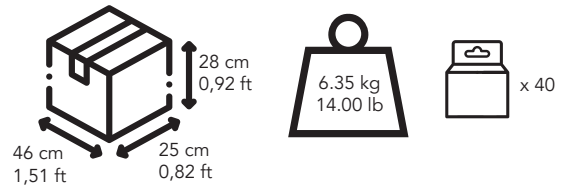

Pallet

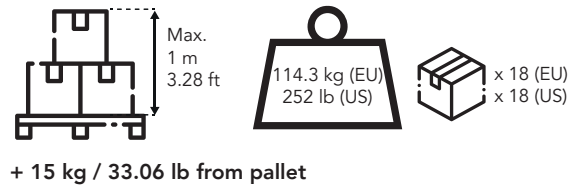

CONTENTS



MAIN APPLICATIONS



CONNECTION GUIDE

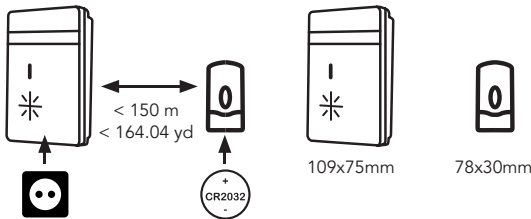

DIMENSIONS

INSTALLATION

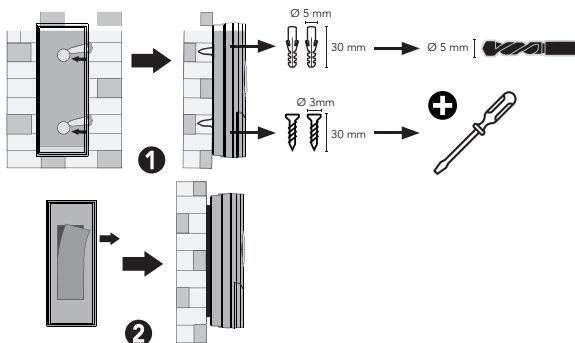



- Electronic operation
- 36 chime melodies
- Reach range of 200m between the transmitter and receiver
- Light indicator when the bell is sounding
- Transmitter with label holder

C-LOGIC 860-DC

Wireless electronic doorbell
 SKU No : CLOGIC860DCCBINT
 EAN Code : 843539477122
 UPC Code : 810053671641

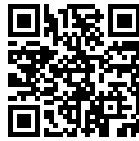

More info

SPECIFICATIONS

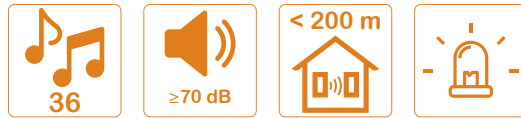

FEATURES

Suitable for indoor use

Possibility of personalization in the switch

Possibility of connecting up to 5 switches to the same bell

According to EN 62080:2009

Power supply: 1xCR2032 included, 2x1.5AA not included

PACKAGING & LOGISTICS INFORMATION

HS Code: 85318040

Carton box

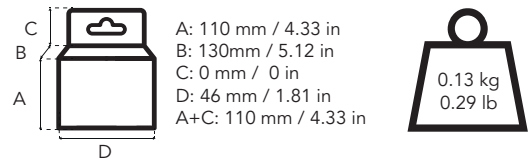

Export carton

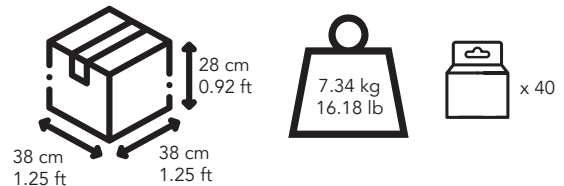

Pallet

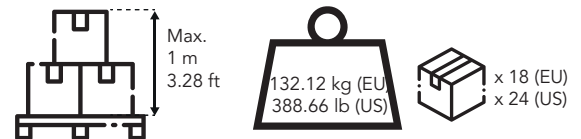

+ 15 kg / 33.06 lb from pallet

CONTENTS



MAIN APPLICATIONS

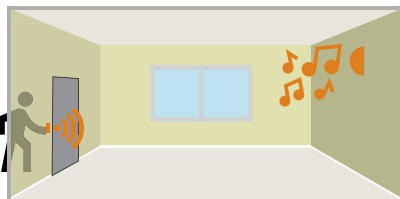

CONNECTION GUIDE

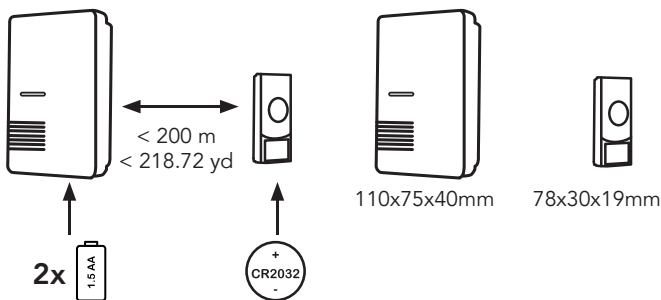

DIMENSIONS

INSTALLATION

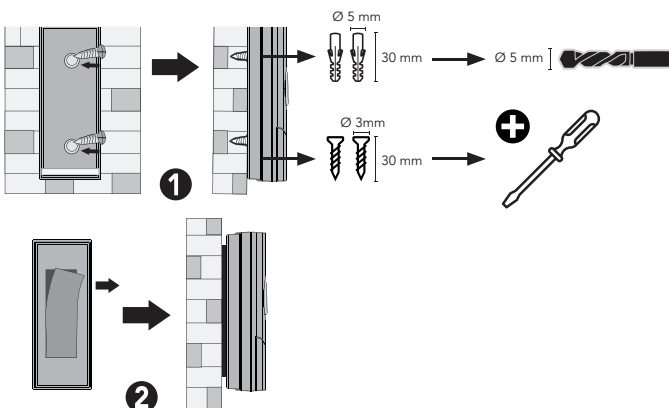



- Smoke detector
- <85dB



C-LOGIC 700-SD

Smoke detector
 SKU No : CLOGIC700SDCBINT
 EAN Code : 8435394748146
 UPC Code : 810053671320



More info

SPECIFICATIONS



FEATURES

Dimensions: 102 x 36 x 69 mm

On-celling installation

Suitable for indoor use

Acoustic indication of low battery

Power supply: 1 x 9V battery included

According to EN 14604:2005 / AC:2008

PACKAGING & LOGISTICS INFORMATION

HS Code: 90278090

Carton box

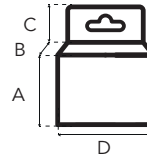

A: 105 mm / 4.13 in
 B: 35 mm / 1.38 in
 C: 0 mm / 0 in
 D: 105 mm / 4.13 in
 A+C: 105 mm / 4.13 in



Export carton

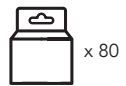
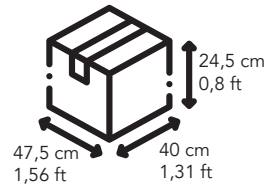

Pallet

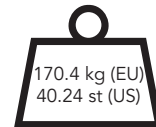
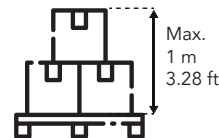

+ 15 kg / 33.06 lb from pallet

CONTENTS



MAIN APPLICATIONS

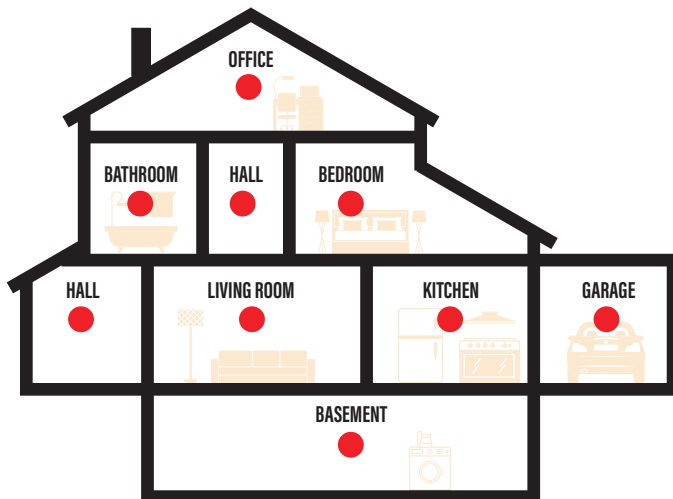

CONNECTION GUIDE

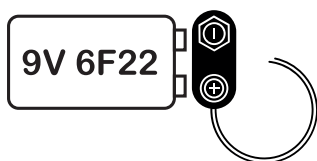

DIMENSIONS



INSTALLATION

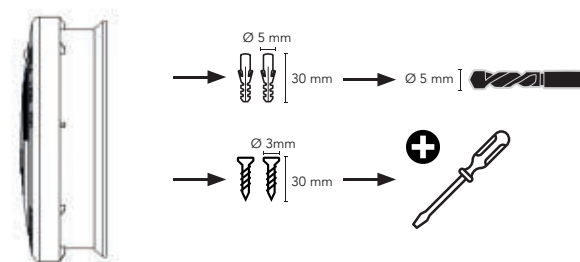



- Mini Smoke detector
- <85dB



C-LOGIC 720-SD

Mini smoke detector
 SKU No : CLOGIC720SDCBINT
 EAN Code : 8435394748160
 UPC Code : 810053671337



More info

SPECIFICATIONS



FEATURES

Dimensions: 72 x 37 mm

On-ceiling installation compact size

Suitable for indoor use

Acoustic indication of detection.

Power supply: 3 x 3V CR2450 batteries included

According to EN 14604:2005/AC:2008

PACKAGING & LOGISTICS INFORMATION

HS Code: 90278090

Carton box

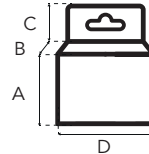

A: 75 mm / 2.95 in
 B: 40 mm / 1.57 in
 C: 0 mm / 0 in
 D: 75 mm / 2.95 in
 A+C: 75 mm / 2.95 in



Export carton

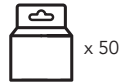
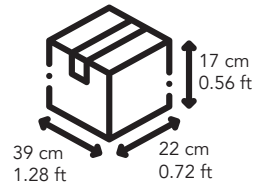

Pallet

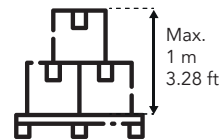

+ 15 kg / 33.06 lb from pallet

CONTENTS



MAIN APPLICATIONS

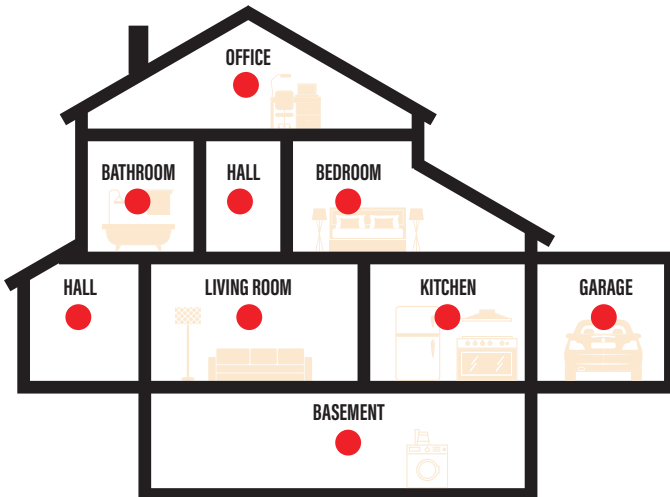

CONNECTION GUIDE



DIMENSIONS



INSTALLATION

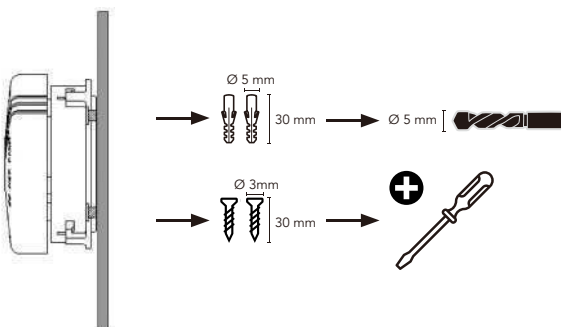



- Wireless Smoke Detector
- <85dB



C-LOGIC 710-SD
 Wireless smoke detector
 SKU No : CLOGIC710SDCBINT
 EAN Code : 843539474817
 UPC Code : 810053671344



More info

SPECIFICATIONS



FEATURES

Dimensions: 128 x 49 mm

On-celling installation

Suitable for indoor use

Acoustic indication of detection

Power supply: 1 x 9V battery + 3 x 1.5V batteries included

Indication light of operation

According to EN 14604:2005 / AC:2008

PACKAGING & LOGISTICS INFORMATION

HS Code: 90278090

Carton box

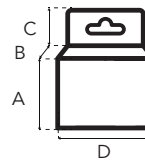

A: 130 mm / 5.12 in
 B: 55 mm / 2.17 in
 C: 0 mm / 0 in
 D: 130 mm / 5.12 in
 A+C: 130 mm / 5.12 in



Export carton

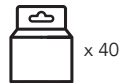
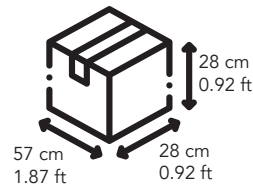

Pallet

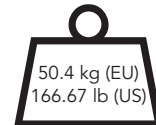
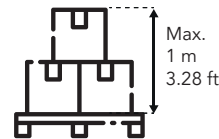

+ 15 kg / 33.06 lb from pallet

CONTENTS

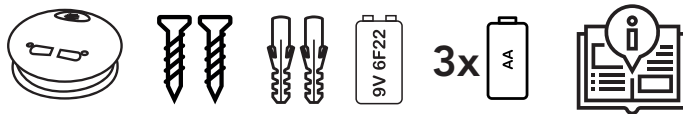

MAIN APPLICATIONS

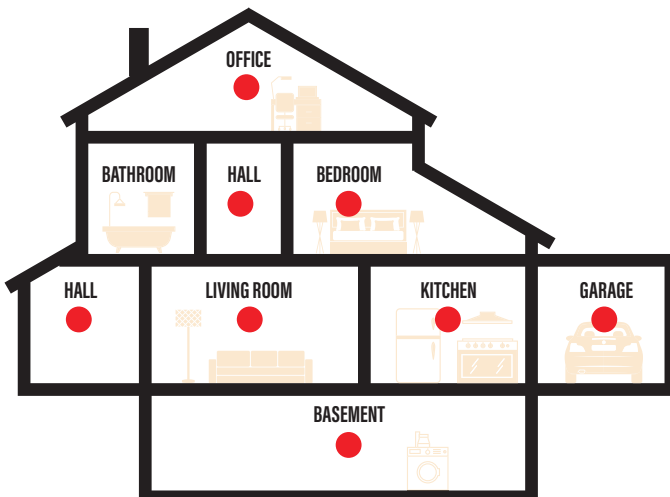

CONNECTION GUIDE

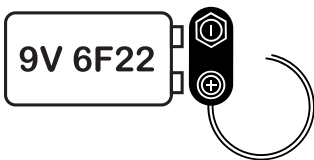

DIMENSIONS



INSTALLATION

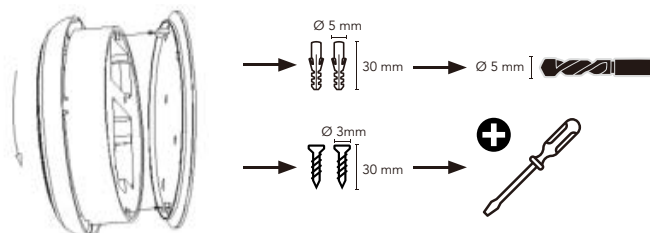



- Gas detector
- Liquid gas and natural gas leakage (LPG) detection
- <85dB



C-LOGIC 770-SD

Gas detector
 SKU No : CLOGIC770SD230VCBINT
 EAN Code : 8435394748184



More info

SPECIFICATIONS



FEATURES

Dimensions: 126 x 73 x 76 mm

On-wall installation

Suitable for indoor use

Liquid gas and natural gas leakage (LPG) detection

Acoustic indication of detection

Alarm level: < 25%LEL

Acoustic indication of detection

Power supply: 230VAC 50-60 Hz

Plug type: Schuko

PACKAGING & LOGISTICS INFORMATION

HS Code: 90278090

Carton box

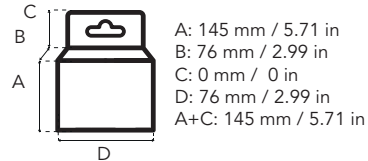

A: 145 mm / 5.71 in
 B: 76 mm / 2.99 in
 C: 0 mm / 0 in
 D: 76 mm / 2.99 in
 A+C: 145 mm / 5.71 in



Export carton

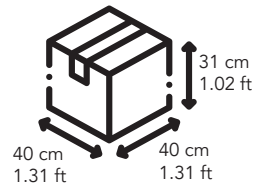

40 cm / 1.31 ft
 40 cm / 1.31 ft
 31 cm / 1.02 ft

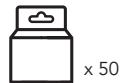

Pallet

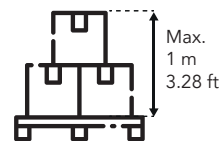

Max.
 1 m
 3.28 ft

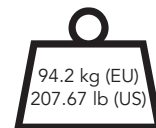

+ 15 kg / 33.06 lb from pallet

CONTENTS



MAIN APPLICATIONS

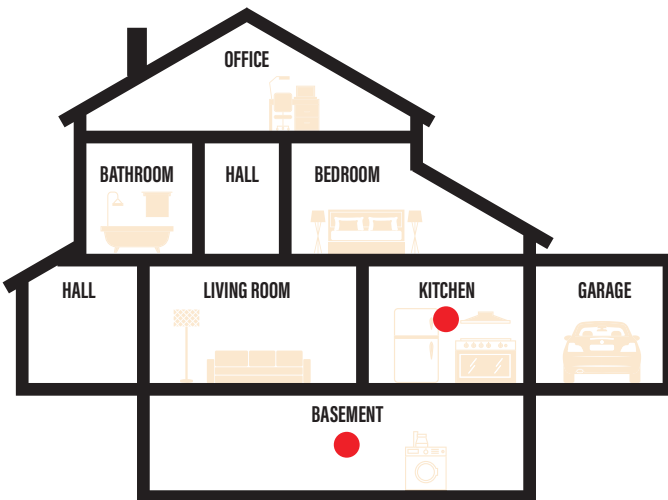

CONNECTION GUIDE

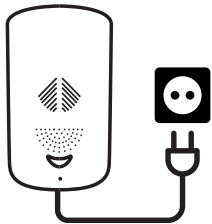

DIMENSIONS

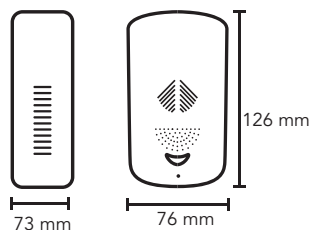

INSTALLATION

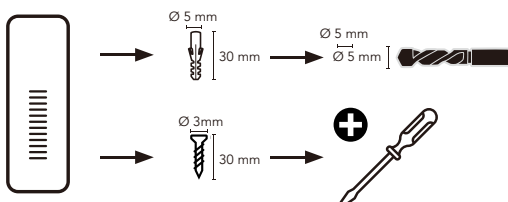



- Suitable for the detection of water filtrations
- <85dB
- Response time: <7 seconds



C-LOGIC 730-SD

Flood detector
 SKU No : CLOGIC730SDCBINT
 EAN Code : 8435394748214
 UPC Code : 810053671375

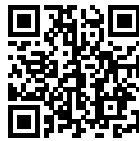

More info

SPECIFICATIONS



FEATURES

Suitable for the detection of water filtrations

Installation on surface

Response time: <7 seconds

Operating temperature: +1°C to 60°C

Power supply: 1 x 9V battery included

Dimensions: 86 x 82 x 30 mm. Weight: 100g

PACKAGING & LOGISTICS INFORMATION

HS Code: 90278090

Carton box

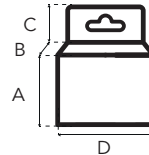

A: 85 mm / 3.35 in
 B: 35 mm / 1.38 in
 C: 0 mm / 0 in
 D: 85 mm / 3.35 in
 A+C: 85 mm / 3.35 in



Export carton

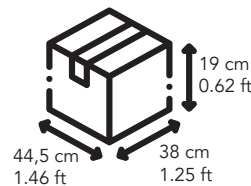

Pallet

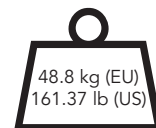
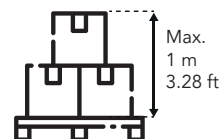

+ 15 kg / 33.06 lb from pallet

CONTENTS

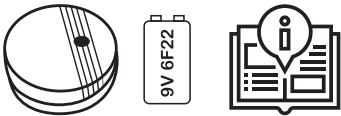

MAIN APPLICATIONS

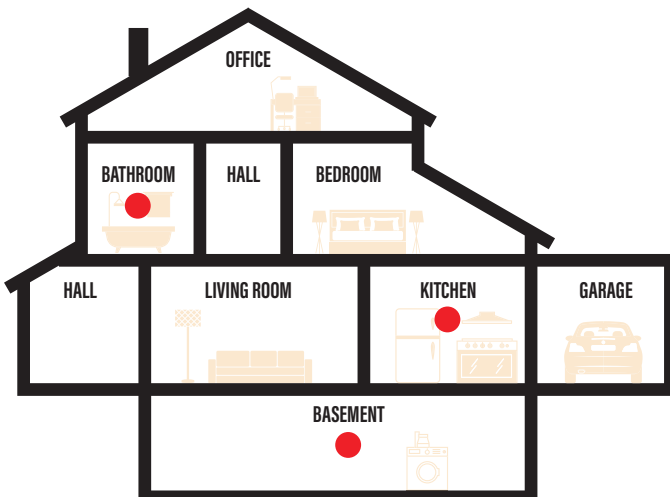

CONNECTION GUIDE

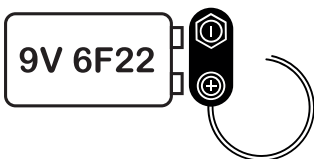

DIMENSIONS

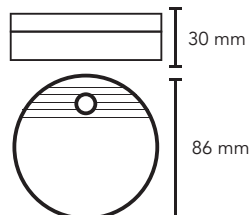

INSTALLATION

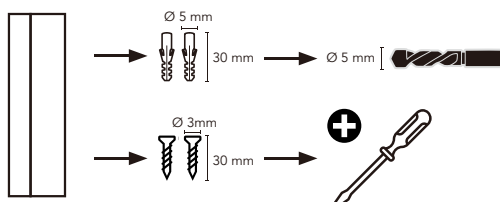



- CO detector
- <85dB



C-LOGIC 750-SD

CO detector
 SKU No : CLOGIC750SDCBINT
 EAN Code : 8435394748191
 UPC Code : 810053671351



More info

SPECIFICATIONS



FEATURES

- On-ceiling installation
- Suitable for indoor use
- LCD screen with visual indication of CO concentration
- Acoustic and light indication of low battery
- Dimensions: 115 x 37 mm. Weight: 120 g
- Power supply: 3 x 1.5V batteries included

PACKAGING & LOGISTICS INFORMATION

HS Code: 90278090

Carton box

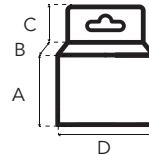

A: 120 mm / 4.72 in
 B: 42 mm / 1.65 in
 C: 0 mm / 0 in
 D: 120 mm / 4.72 in
 A+C: 120 mm / 4.72 in



Export carton

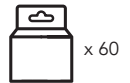
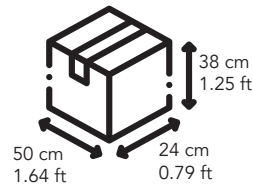

Pallet

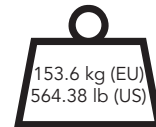
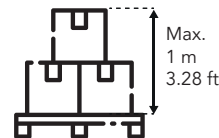

+ 15 kg / 33.06 lb from pallet

CONTENTS



MAIN APPLICATIONS

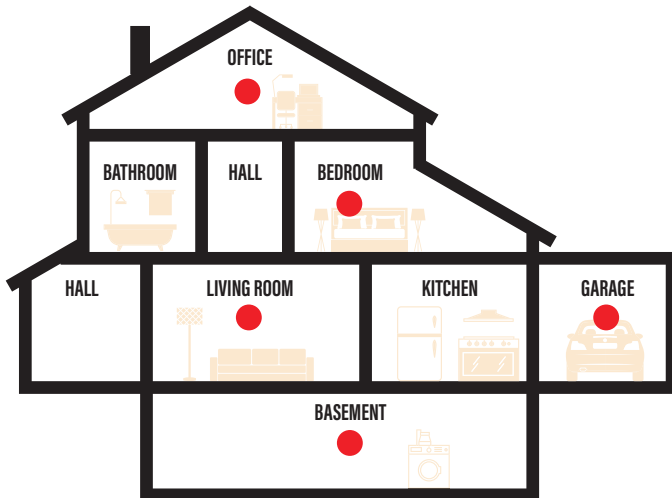

CONNECTION GUIDE

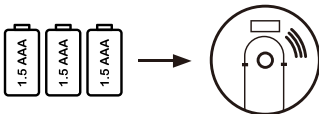

DIMENSIONS

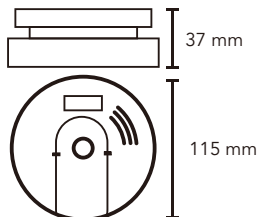

INSTALLATION

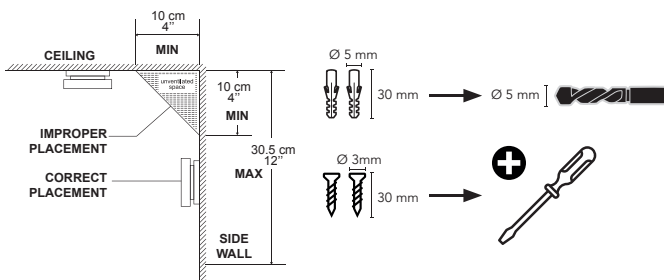



- CO + Smoke detector
- <85dB



C-LOGIC 740-SD

CO+Smoke detector
 SKU No : CLOGIC740SDCBINT
 EAN Code : 8435394776842
 UPC Code : 810053671481



More info

SPECIFICATIONS



FEATURES

On-celling installation

Suitable for indoor use

LCD screen with visual indication of CO concentration and of smoke detection

Acoustic and light indication of low battery

Indication light of operation via LED

Dimensions: 115 x 37 mm. Weight: 120 g

Power supply: 1 x 9V batteries included

PACKAGING & LOGISTICS INFORMATION

HS Code: 84306243

Carton box

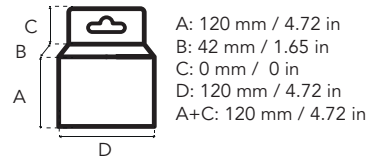

Export carton

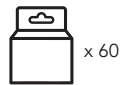
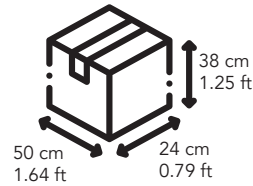

Pallet

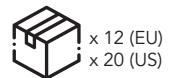
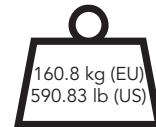
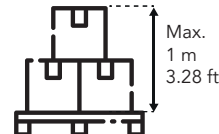

+ 15 kg / 33.06 lb from pallet

CONTENTS

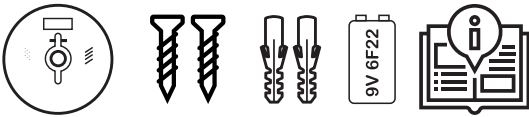

MAIN APPLICATIONS

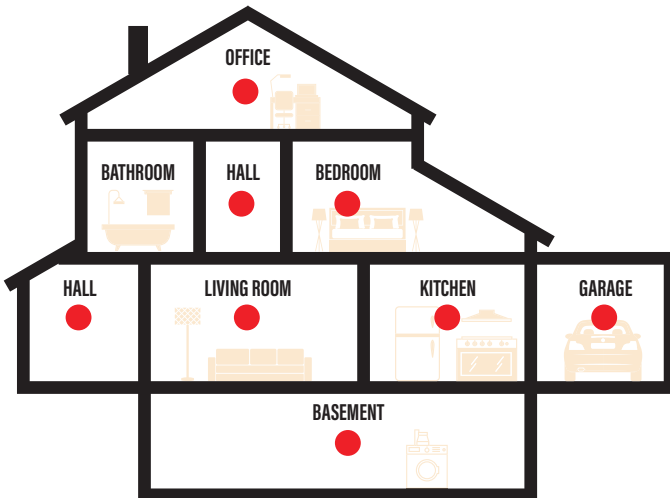

CONNECTION GUIDE

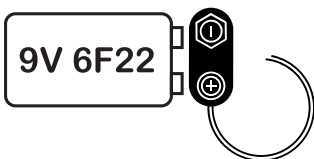

DIMENSIONS

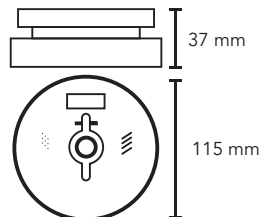

INSTALLATION

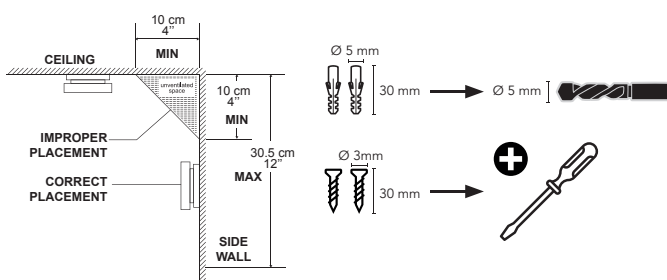



- Suitable for the detection of early signs of fire
- <85dB
- Detection temperature 55±5 °C



C-LOGIC 760-SD

Fire detector
 SKU No : CLOGIC760SDCBINT
 EAN Code : 8435394748207
 UPC Code : 810053671368



More info

SPECIFICATIONS



FEATURES

- On-wall or on-ceiling installation
- Suitable for indoor use
- Detection temperature 55±5 °C
- Acoustic and light indication of low battery
- Dimensions: 107 x 107 x 37.5 mm. Weight: 220 g
- Power supply: 1 x 9V battery included

PACKAGING & LOGISTICS INFORMATION

HS Code: 90278090

Carton box

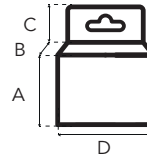

A: 115 mm / 4.53 in
 B: 55 mm / 2.17 in
 C: 35.5 mm / 1.40 in
 D: 115 mm / 4.53 in
 A+C: 150.5 mm / 5.93 in



Export carton

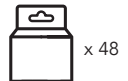
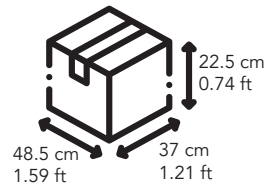

Pallet

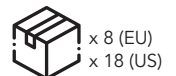
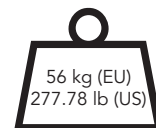
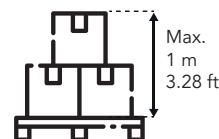

+ 15 kg / 33.06 lb from pallet

CONTENTS

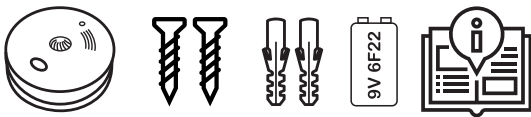

MAIN APPLICATIONS

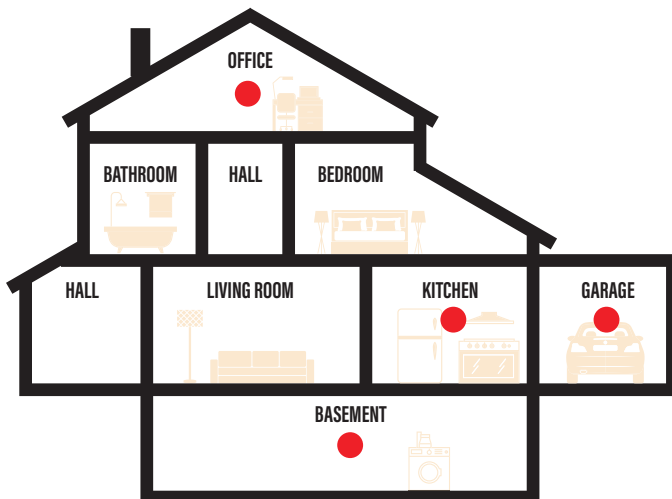

CONNECTION GUIDE

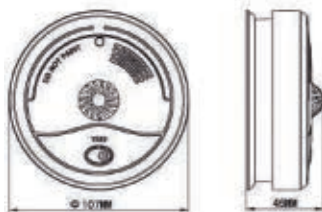
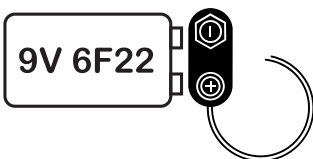

INSTALLATION

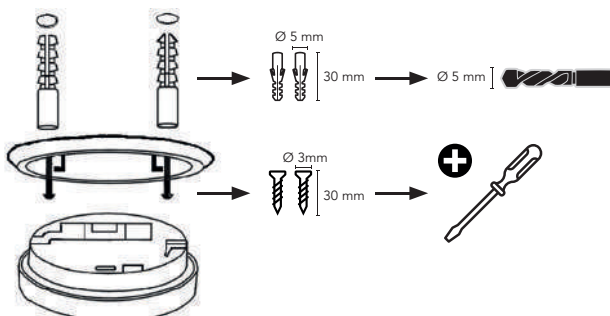



- Digital thermostat for heating or cooling units



C-LOGIC 400-TC

Digital thermostat
 SKU No : CLOGIC400TCCBINT
 EAN Code : 8435394776750
 UPC Code : 810053671429



More info

CONTENTS

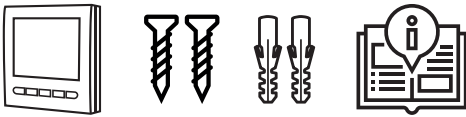

MAIN APPLICATIONS

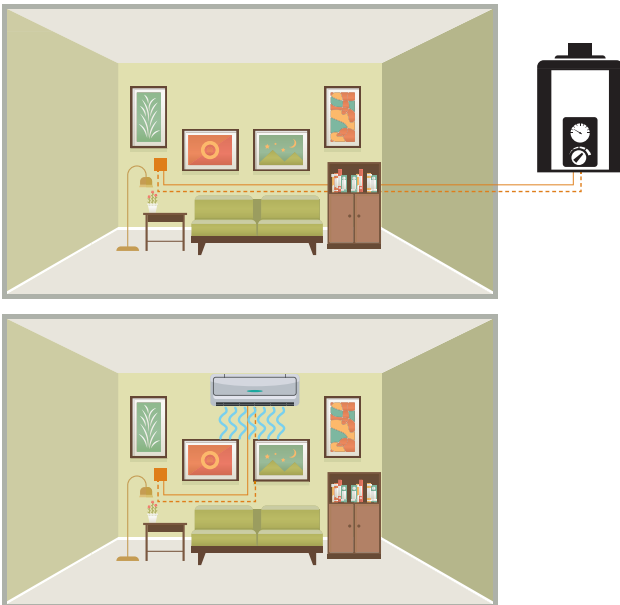

CONNECTION GUIDE

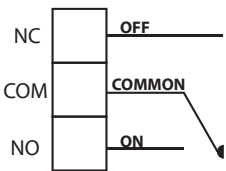

NC: Normally close contact
 COM: Common terminal
 NO: Normally open contact

DIMENSIONS

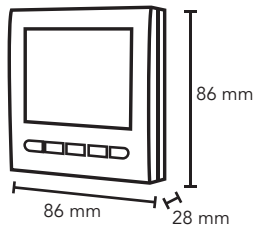

INSTALLATION

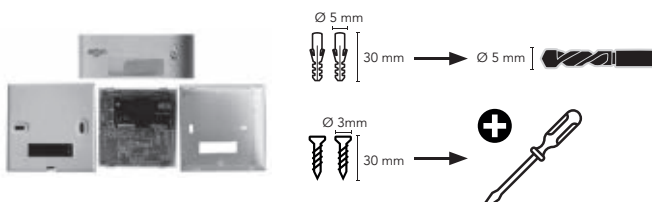

SPECIFICATIONS



FEATURES

- Wall mounted
- LCD screen with backlight display for viewing of the room temperature and set-point temperature
- Free-potential change-over contact with a maximum capacity of 3A
- Programming in 6 daily intervals for working days and 2 daily intervals for weekend
- Accuracy of measured temperature: 0.5°C
- Range of set temperature from 5°C to 35°C
- Frost protection mode
- Room temperature calibration function
- Powered by 2 AA x 1.5V batteries (not included)
- Dimensions: 86x86x28 mm

PACKAGING & LOGISTICS INFORMATION

HS Code: 90321020

Carton box

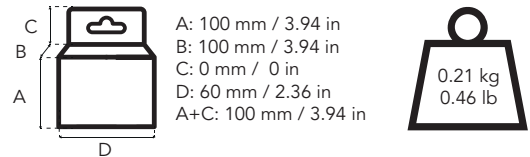

Export carton

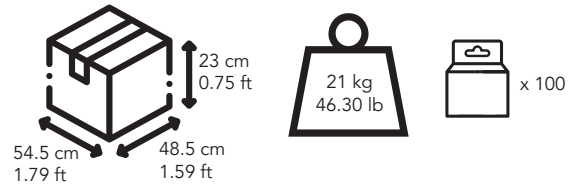

Pallet

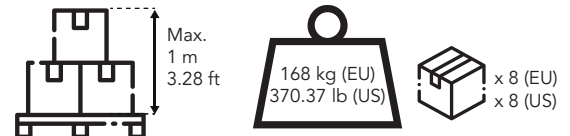

+ 15 kg / 33.06 lb from pallet



- Digital programmable thermostat for heating or cooling units.

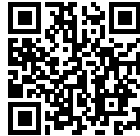

More info

C-LOGIC 410-TC

Digital programmable thermostat
 SKU No : CLOGIC410TCCBINT
 EAN Code : 8435394776767
 UPC Code : 810053671436

CONTENTS



MAIN APPLICATIONS

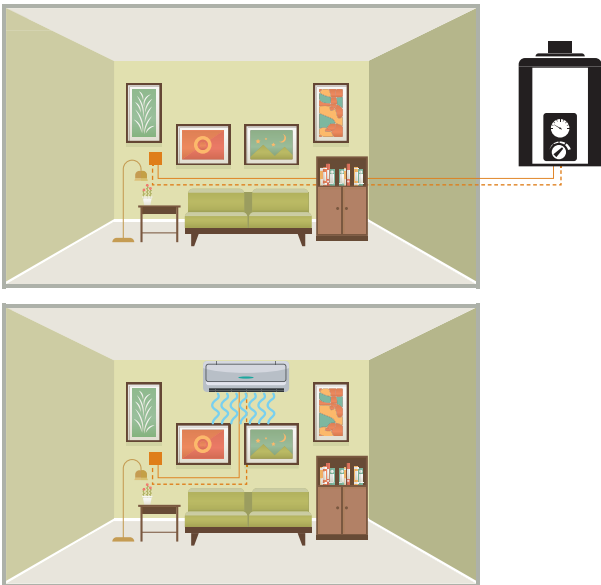

INSTALLATION

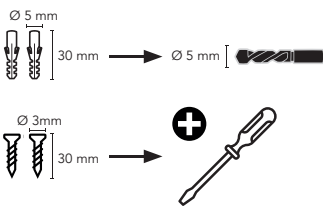

DIMENSIONS

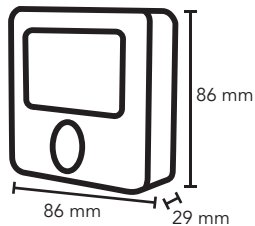

SPECIFICATIONS



FEATURES

- Wall mounted
- LCD screen with backlight display for viewing the room temperature and the set-point temperature
- Free-potential change-over contact with a maximum capacity of 5A/250V
- Manual, automatic or holiday mode
- Hour-by-hour programming. Two pre-set programs included
- Manual setting of comfortable and energy-saving temperatures
- Range of measured temperature: 0°C-40°C
- Accuracy of measured temperature: 0.5°C
- Range of set temperature from 5°C to 35°C
- Frost protection mode
- Room temperature calibration function
- Powered by 2 x 1.5V batteries (not included)
- Dimensions: 86x86x29 mm

PACKAGING & LOGISTICS INFORMATION

HS Code: 90321020

Carton box

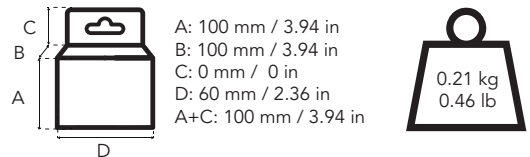

Export carton

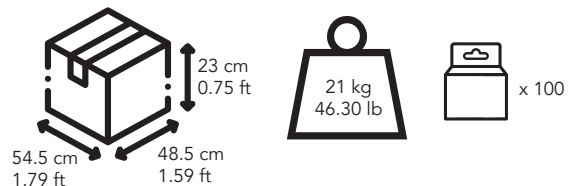

Pallet



CONNECTION GUIDE

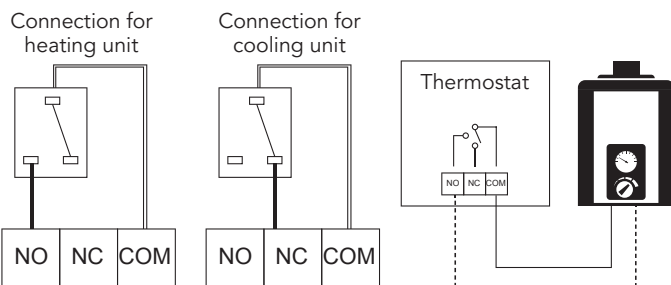



- RF Digital programmable thermostat for heating or cooling units.
- Transmitter and a receiver communicated via radio frequency.



C-LOGIC 420-TC

Digital RF programmable thermostat
 SKU No : CLOGIC420TC230VCBINT
 EAN Code : 8435394776965



More info

SPECIFICATIONS

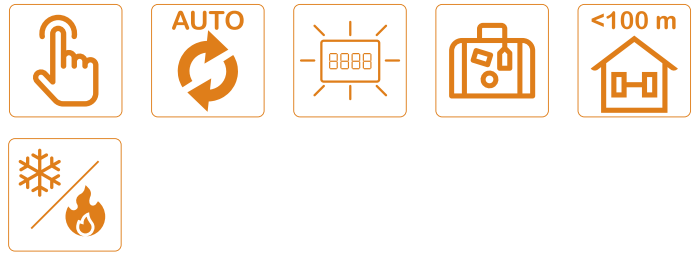

FEATURES

- Wall mounted
- The thermostat consists of a transmitter and a receiver communicated via radio frequency
- Communication distance up to 100 m (more than 30 m inside the buildings)
- LCD screen with backlight display for viewing the room temperature and set-point temperature
- Free-potential change-over contact with a maximum capacity of 5A/230V
- Manual, automatic or holiday mode
- Programming in 6 daily intervals. Two pre-set programs included
- Range of measured temperature: 0°C-40°C
- Accuracy of measured temperature: 0.5°C
- Range of set temperature from 5°C to 35°C
- Room temperature calibration function
- Power supply:
 - Transmitter: 2 AA x 1.5V batteries (not included)
 - Receiver: Connected to the mains (230V 50/60Hz)

PACKAGING & LOGISTICS INFORMATION

HS Code: 90321020

Carton box

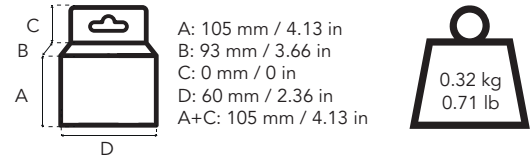

Export carton

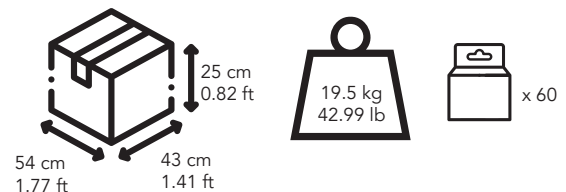

Pallet

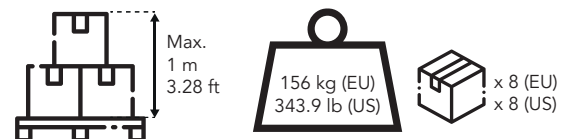

+ 15 kg / 33.06 lb from pallet

CONTENTS

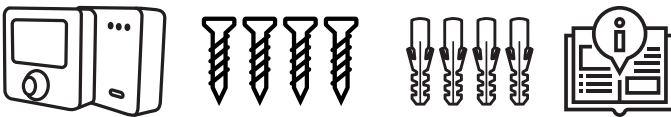

MAIN APPLICATIONS

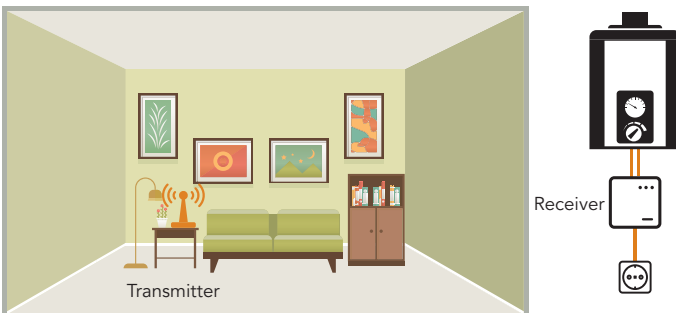

CONNECTION GUIDE

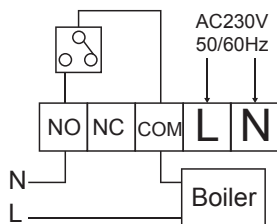

DIMENSIONS

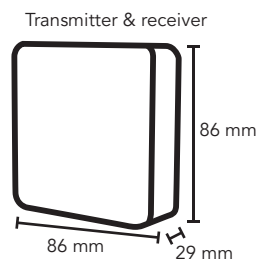

INSTALLATION

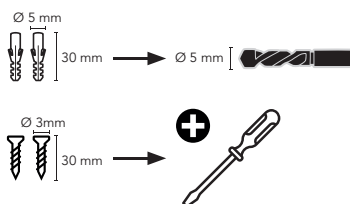



- Wifi digital programmable thermostat for heating units.
- Remote control via Wifi by mobile App. Compatible with Alexa
- TUYA platform connectivity, allows the control of different devices with one App



C-LOGIC 900-TC

Digital Wifi programmable thermostat
 SKU No : CLOGIC900TCDUALCBINT
 EAN Code : 8435394776972



More info

CONTENTS



MAIN APPLICATIONS

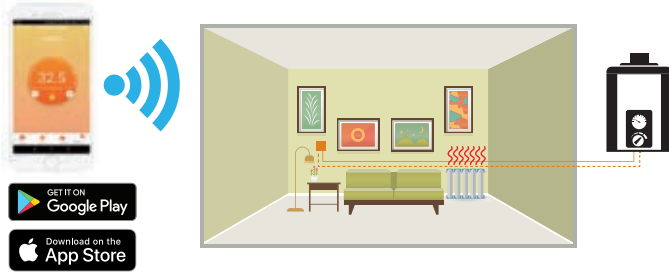

CONNECTION GUIDE

AC90-240V 50/60Hz
 I_{max}: 3A

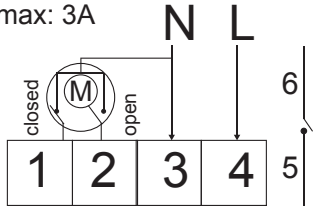

DIMENSIONS

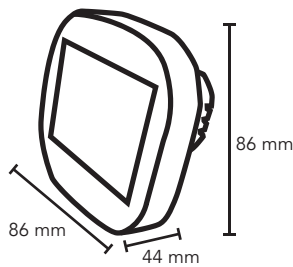

INSTALLATION

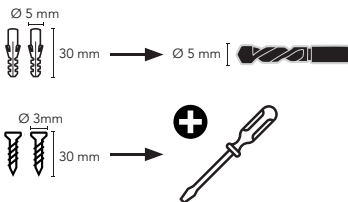

SPECIFICATIONS



FEATURES

- Installation in flush-mount box
- Remote control via Wifi by mobile App. Compatible with Alexa
- TUYA platform connectivity, allows the control of different devices with one App
- LCD screen with backlight display for viewing the room temperature and set-point temperature
- Free-potential normally-open contact with a maximum capacity of 3A/230V
- Manual, automatic or holiday mode
- Programming in 6 daily intervals
- Range of measured temperature: 0°C-70°C
- Accuracy of measured temperature: 0.5°C
- Range of set temperature from 5°C to 35°C
- Room temperature calibration function
- Power supply: Connected to the mains (90- 240V 50/60Hz)
- Dimensions: 86x86x44 mm

PACKAGING & LOGISTICS INFORMATION

HS Code: 90321020

Carton box

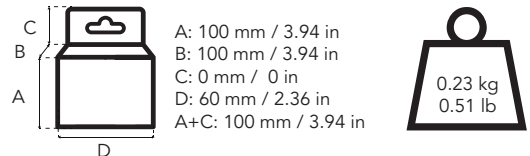



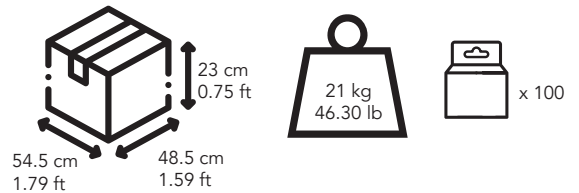

Export carton

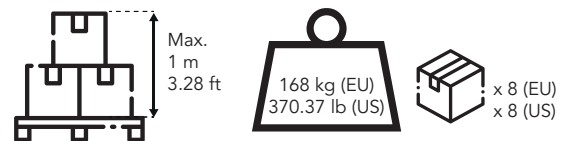

Pallet



+ 15 kg / 33.06 lb from pallet

FUNCTIONS				
	C-LOGIC 400-TC	C-LOGIC 410-TC	C-LOGIC 420-TC	C-LOGIC 900-TC
SKU NO.	CLOGIC400TCCBINT	CLOGIC410TCCBINT	CLOGIC420TC 230VCBINT	CLOGIC900TC DUALCBINT
Installation	Surface	Surface	Surface	Surface
Power supply	2 batteries AA 1.5V	2 batteries AA 1.5V	Emisor: 2 batteries AA 1.5V Receptor: 230V 50/60Hz"	90-230VAC, 50/60Hz
Temperature range	+5°C - +35°C	+5°C - +35°C	+5°C - +35°C	+5°C - +35°C
Switch ON/OFF	✓	✓	✓	✓
Switch ON indicator	✓	✓	✓	✓
Backlight display	✓	✓	✓	✓
Operation moods	Manual/Automatic	Manual/Automatic /Holidays	Manual/Automatic /Holidays	Manual/Automatic /Holidays
Programming type	Weekly	Weekly	Weekly	Weekly
AUTO programs	Working days: 6 intervals Weekend: 2 intervals	Hour-by-hour programming. Two pre-set programs included	Programming in 6 daily intervals. Two pre-set programs included	6 daily intervals
Frost protection mode	✓	✓	-	-
Room temperature calibration function	✓	✓	✓	✓
Contact Capability	3A	5A	5A / 230VAC	3A / 230VAC
Switched contact	Cooling & Heating	Cooling & Heating	Cooling & Heating	NA (Heating)
Communication	-	-	Radionfrquency	Wifi
App for smartphone	-	-	-	✓



- Up to 48 commands per day on / off
- Min operation: 30 minutes



C-LOGIC 300-PT

Plug-In Mechanical Time-Switch
 SKU No : CLOGIC300PT125VCBINT
 EAN Code : 8435394776804
 UPC Code : 810053671443



More info

CONTENTS



MAIN APPLICATIONS

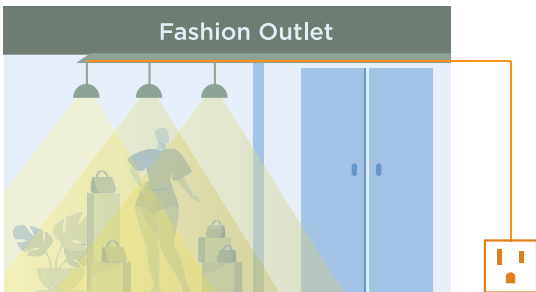

CONNECTION GUIDE

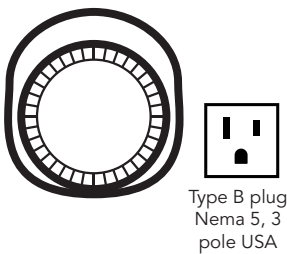

DIMENSIONS

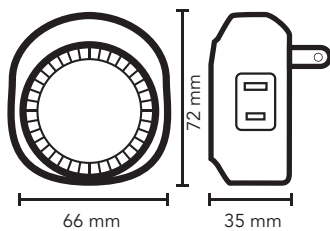

INSTALLATION

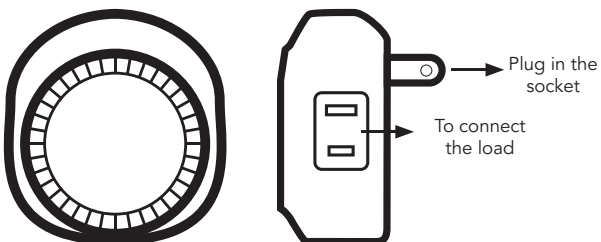

SPECIFICATIONS

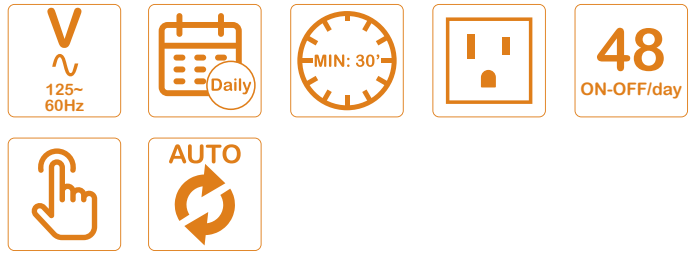

FEATURES

- Up to 48 programs per day
- Power supply: 125V~, 50-60Hz
- Min operation: 30 minutes
- Max Load: 15A (Resistive)
- Operation modes: ON/AUTO

PACKAGING & LOGISTICS INFORMATION

HS Code:

Carton box

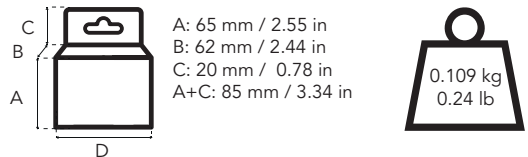

Export carton

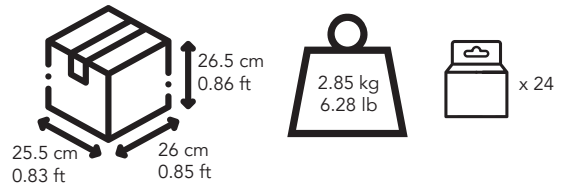

Pallet

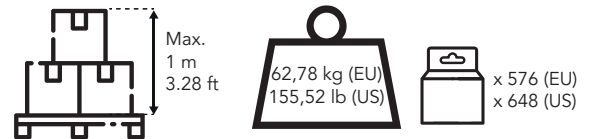

+ 15 kg / 33.06 lb from pallet



- Set specific on / off times for your appliances such as coffeemaker, lamps, etc.
- Ideal for energy saving
- Large LCD screen, shows the status of the selected program and the real time



C-LOGIC 310-PT

Plug-In Digital Time-Switch
 SKU No : CLOGIC310PT125VCBINT
 EAN Code : 8435394776811
 UPC Code : 810053671450



More info

CONTENTS



MAIN APPLICATIONS



CONNECTION GUIDE

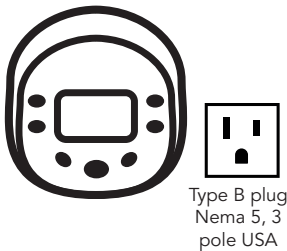

Type B plug
Nema 5, 3
pole USA

DIMENSIONS

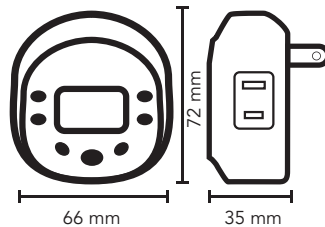

INSTALLATION

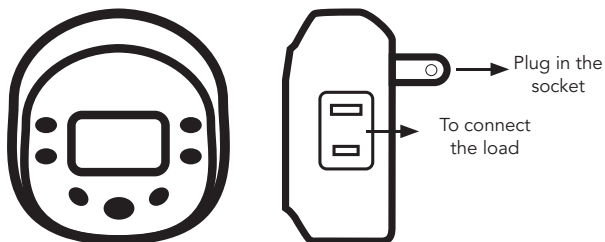

SPECIFICATIONS

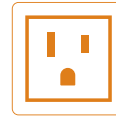

FEATURES

Maximum of 140 weekly on/off programs

Power supply: 125V~, 50-60Hz

Minimum 1 min interval

Max Load: 15A (Resistive)

Operation modes: ON/OFF/AUTO

PACKAGING & LOGISTICS INFORMATION

HS Code: 9106900000

Carton box

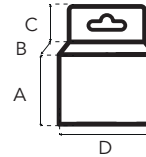

A: 65 mm / 2.55 in
 B: 79 mm / 3.11 in
 C: 20 mm / 0.78 in
 A+C: 85 mm / 3.34 in



Export carton

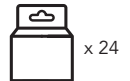
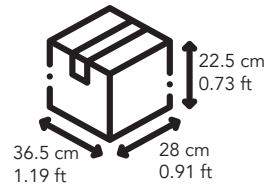

Pallet

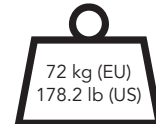
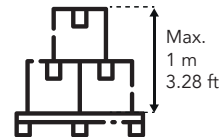

+ 15 kg / 33.06 lb from pallet



INSTALLATION

- FISH TAPES
- CONNECTORS AND TERMINALS

SYMBOL	DESCRIPTION
	Diameter
	Available lengths
	Max. tensile strength
	Optimal tube diameter
	Cable terminals
	Interchangeables terminals
	Head rotation
	Fish tapes reels diameters
	Biodegradable

SYMBOL	DESCRIPTION
	Non corrosive
	Non toxic
	Non flammable
	Surge protection
	Ph neutral
	Dropper
	Protection degree
	Drying time
	Insulation power



- Made on Nylon
- Diameter: 3 mm.
- Fixed spring terminals
- Natural color
- Good Resistance
- Durability.
- High Flexibility
- Different models with different lengths



More info

C-LOGIC 300 series

Nylon cable guides

SPECIFICATIONS

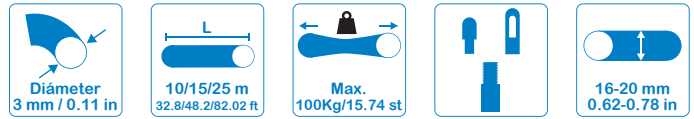

Ref. Name	Length	Diameter	Tensile Strength	Terminals
C-LOGIC 310N-FT	10 m	3 mm	100 kg	Fixed
C-LOGIC 315N-FT	15 m	3 mm	100 kg	Fixed
C-LOGIC 325N-FT	25 m	3 mm	100 kg	Fixed

PACKAGING & LOGISTICS INFORMATION

HS Code: 82055980

Check available packaging options.

ARTICLE	C-LOGIC 310N-FT	C-LOGIC 315N-FT	C-LOGIC 325N-FT
SKU No.	CLOGIC310NFTCBINT	CLOGIC315NFTCBINT	CLOGIC325NFTCBINT
EAN	8435394777139	8435394777146	8435394777153
UPC	810053671658	810053671665	810053671672

CONTENTS

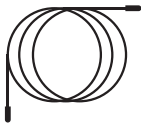

MAIN APPLICATIONS



DOMESTIC

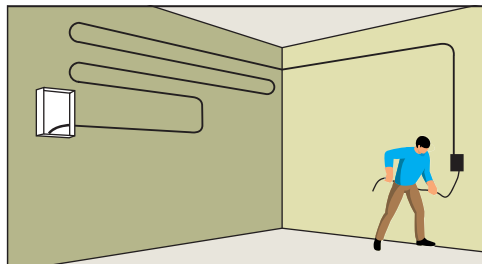

INDUSTRIAL

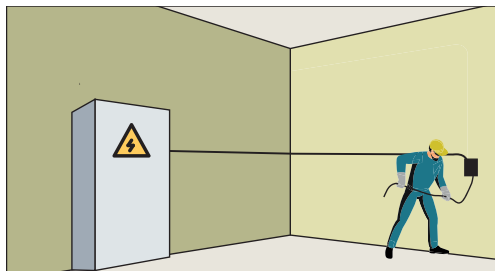



- Shrink wrapping Polipropilen cover with Internal Steel cord.
- Diameter: 4 mm.
- Interchangeables terminals (M5)
- Orange Color
- High resistance and durability
- Different models with different lengths



C-LOGIC 400 series

Polypropylen cable guides



More info

ARTICLE	C-LOGIC 410SC-FT	C-LOGIC 415SC-FT	C-LOGIC 425SC-FT
SKU No.	CLOGIC410SCFTCBINT	CLOGIC415SCFTCBINT	CLOGIC425SCFTCBINT
EAN	8435394777160	8435394777177	8435394777184
UPC	810053671689	810053671696	810053671702

SPECIFICATIONS

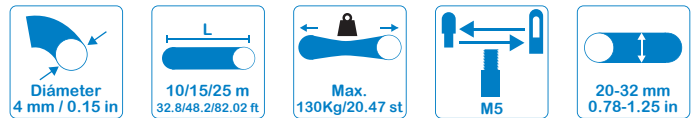

Ref. Name	Length	Diameter	Tensile Strength	Terminals
C-LOGIC 410SC-FT	10 m	4 mm	130 kg	Interchangeables
C-LOGIC 415SC-FT	15 m	4 mm	130 kg	Interchangeables
C-LOGIC 425SC-FT	25 m	4 mm	130 kg	Interchangeables

PACKAGING & LOGISTICS INFORMATION

HS Code: 82055980

Check available packaging options.

CONTENTS

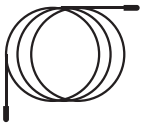

MAIN APPLICATIONS



DOMESTIC

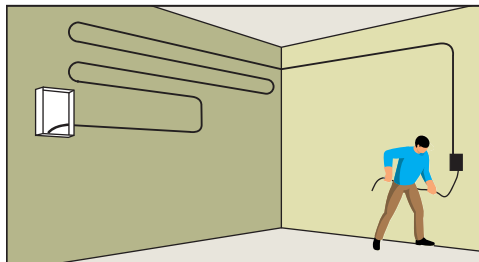

INDUSTRIAL

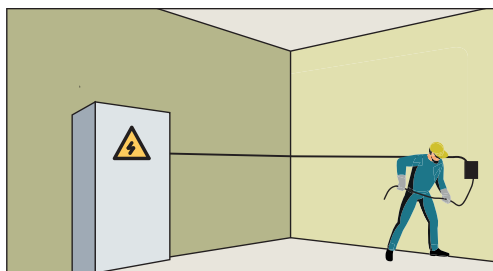



- Braided polyamide
- Diameter: 5-6,3 mm.
- Interchangeable terminals (M5)
- Orange Color
- High resistance and durability
- Different models with different lengths



More info

C-LOGIC 500 series

Polyamide braided cable guides

ARTICLE	C-LOGIC 510BC-FT	C-LOGIC 515BC-FT
SKU No.	CLOGIC510BCFTCBINT	CLOGIC515BCFTCBINT
EAN	8435394777191	8435394777207
UPC	810053671719	810053671726

ARTICLE	C-LOGIC 525BC-FT	C-LOGIC 720BC-FT
SKU No.	CLOGIC525BCFTCBINT	CLOGIC720BCFTCBINT
EAN	8435394777214	8435394777221
UPC	810053671733	810053671740

CONTENTS

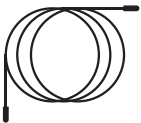

MAIN APPLICATIONS



DOMESTIC

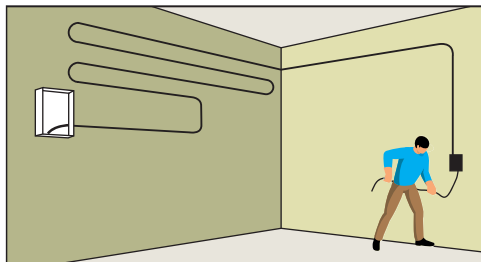

INDUSTRIAL

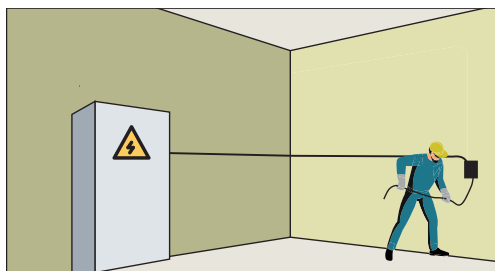

SPECIFICATIONS

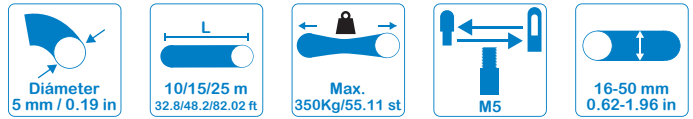

Ref. Name	Length	Diameter	Tensile Strength	Terminals
C-LOGIC 510BC-FT	10 m	5 mm	350 kg	Interchangeables
C-LOGIC 515BC-FT	15 m	5 mm	350 kg	Interchangeables
C-LOGIC 525BC-FT	25 m	5 mm	350 kg	Interchangeables
C-LOGIC 720BC-FT	20 m	6.3 mm	500 kg	Interchangeables

PACKAGING & LOGISTICS INFORMATION

HS Code: 82055980

Check available packaging options.

FUNCTIONS						
	C-LOGIC 310N-FT CBINT	C-LOGIC 315N-FT CBINT	C-LOGIC 325N-FT CBINT	C-LOGIC 410SC-FT CBINT	C-LOGIC 415SC-FT CBINT	C-LOGIC 425SC-FT CBINT
SKU NO.	CLOGIC310NFT CBINT	CLOGIC315NFT CBINT	CLOGIC325NFT CBINT	CLOGIC410SCFT CBINT	CLOGIC415SCFT CBINT	CLOGIC425SCFT CBINT
Length	10m	15m	25m	10m	10m	25m
Diameter	3mm	3mm	3mm	4mm	4mm	4mm
Terminals	Fixed	Fixed	Fixed	Interchangeables	Interchangeables	Interchangeables
Tensile Strength	100kg	100kg	100kg	130kg	130kg	130kg

FUNCTIONS				
	C-LOGIC 510BC-FT CBINT	C-LOGIC 515BC-FT CBINT	C-LOGIC 525BC-FT CBINT	C-LOGIC 720BC-FT CBINT
SKU NO.	CLOGIC510BCFT CBINT	CLOGIC515BCFT CBINT	CLOGIC525BCFT CBINT	CLOGIC720BCFT CBINT
Length	10m	15m	25m	20m
Diameter	5mm	5mm	5mm	6.3mm
Terminals	Interchangeables	Interchangeables	Interchangeables	Interchangeables
Tensile Strength	350kg	350kg	350kg	500kg



- Suitable for all types of LV conductors.
- Stripping of insulation is avoided.
- Suitable for aluminum and copper conductors.
- Insulation material: weather resistant glass fiber reinforced polymer.
- Contact teeth material: brass or copper or aluminum.
- Bolt material: dacromet steel.

Piercing connectors series

ARTICLE	C-LOGIC 295-IC	C-LOGIC 2150-IC
SKU No.	CL295ICPEINT	CL2150ICPEINT
EAN	8435394787688	8435394787695
SPECIFICATIONS		
Main line 2 section mm	16-95	50-150
Branch line 2 section mm	4-35(50)	6-35(50)
PACKAGING INFORMATION		
Individual with label		



- Pre-insulated Fork Terminal
- Insulation material: Vinyl
- Terminal body: Copper

Preinsulated terminals series

ARTICLE	C-LOGIC 315F-IT	C-LOGIC 415F-IT	C-LOGIC 425F-IT	C-LOGIC 525F-IT	C-LOGIC 546F-IT	C-LOGIC 646F-IT
SKU No.	CL315FITPEINT	CL415FITPEINT	CL415FITPEINT	CL525FITPEINT	CL546FITPEINT	CL646FITPEINT
EAN	8435394787299	8435394787305	8435394787312	8435394787329	8435394787336	8435394787343
SPECIFICATIONS						
Wire Range (mm ²)	0.5-1.5	0.5-1.5	1.5-2.5	1.5-2.5	4-6	4-6
Stud Size (mm)	3.5	4	4	5	5	6
PACKAGING INFORMATION						
Plastic Bag with Eurohole - 50pcs						



- Pre-insulated Ring Terminal
- Insulation material: Vinyl
- Terminal body: Copper
- Plating: Tin

Preinsulated terminals series

ARTICLE	C-LOGIC 315R-IT	C-LOGIC 415R-IT	C-LOGIC 515R-IT	C-LOGIC 325R-IT	C-LOGIC 425R-IT	C-LOGIC 525R-IT
SKU No.	CL315RITPEINT	CL415RITPEINT	CL515RITPEINT	CL325RITPEINT	CL425RITPEINT	CL525RITPEINT
EAN	8435394787350	8435394787367	8435394787374	8435394787381	8435394787398	8435394787404

SPECIFICATIONS

Wire Range (mm ²)	0.5-1.5	0.5-1.5	0.5-1.5	1.5-2.5	1.5-2.5	1.5-2.5
Stud Size (mm)	3.5	4	5	3.5	4	5

PACKAGING INFORMATION

Plastic Bag with Eurohole - 50pcs

ARTICLE	C-LOGIC 446R-IT	C-LOGIC 546R-IT	C-LOGIC 646R-IT
SKU No.	CL446RITPEINT	CL546RITPEINT	CL646RITPEINT
EAN	8435394787411	8435394787428	8435394787435

SPECIFICATIONS

Wire Range (mm ²)	4-6	4-6	4-6
Stud Size (mm)	4	5	6

PACKAGING INFORMATION

Plastic Bag with Eurohole - 50pcs



- Pre-insulated Tab
- Insulation material: Vinyl
- Terminal body: Copper
- Plating: Tin

Preinsulated terminals series

ARTICLE	C-LOGIC 615T-IT	C-LOGIC 625T-IT	C-LOGIC 646T-IT
SKU No.	CL615TITPEINT	CL625TITPEINT	CL646TITPEINT
EAN	8435394787442	8435394787459	8435394787466

SPECIFICATIONS

Wire Range (mm ²)	1.5-2.5	1.5-2.5	4-6
NEMA TAB (TxW)	0.8x6.35 .020x.250	0.8x6.35 .032x.250	0.8x6.35 .032x.250

PACKAGING INFORMATION

Plastic Bag with Eurohole - 50pcs



- Pre-insulated Receptacle
- Insulation material: Vinyl
- Terminal body: Copper
- Plating: Tin

Preinsulated terminals series

ARTICLE	C-LOGIC 615D-IT	C-LOGIC 625D-IT	C-LOGIC 646D-IT
SKU No.	CL615DITPEINT	CL625DITPEINT	CL646DITPEINT
EAN	8435394787473	8435394787480	8435394787497

SPECIFICATIONS

Wire Range (mm ²)	0.5-1.5	1.5-2.5	4-6
NEMA TAB (TxW)	0.8x6.35 .032x.250	0.8x6.35 .032x.250	0.8x6.35 .032x.250

PACKAGING INFORMATION

Plastic Bag with Eurohole - 50pcs



- Pre-insulated Pin Terminal
- Insulation material: Vinyl
- Terminal body: Copper
- Plating: Tin

Preinsulated terminals series

ARTICLE	C-LOGIC 1915P-IT	C-LOGIC 19125P-IT	C-LOGIC 3046P-IT
SKU No.	CL1915PITPEINT	CL19125PITPEINT	CL3046PITPEINT
EAN	8435394787503	8435394787510	8435394787527

SPECIFICATIONS

Wire Range (mm ²)	0.5-1.5	1.5-2.5	4-6
Dimension	W1.9xF12xL21.8	W1.9xF12xL21.8	W2.8xF13xL27

PACKAGING INFORMATION

Plastic Bag with Eurohole - 50pcs



- Pre-insulated Connectors
- Insulation material: Vinyl
- Terminal body: Copper
- Plating: Tin

Preinsulated terminals series

ARTICLE	C-LOGIC 1815S-IT	C-LOGIC 1825S-IT	C-LOGIC 2346S-IT	C-LOGIC 3510S-IT	C-LOGIC 4516S-IT
SKU No.	CL1815SITPEINT	CL1825SITPEINT	CL2346SITPEINT	CL3510SITPEINT	CL4516SITPEINT
EAN	8435394787534	8435394787541	8435394787558	8435394787565	8435394787572

SPECIFICATIONS

Wire Range (mm ²)	0.5-1.5	1.5-2.5	4-6	8	14
Dimension	Ø4.0xL24.6	Ø4.5xL24.6	Ø6.3xL26.5	Ø8.5xL35.5	Ø10.5xL45

PACKAGING INFORMATION

Plastic Bag with Eurohole - 50pcs



- Insulation material: Nylon
- Metal: Copper

Cord End terminals series

ARTICLE	C-LOGIC 188-ET	C-LOGIC 258-ET	C-LOGIC 410-ET	C-LOGIC 612-ET	C-LOGIC 1012-ET	C-LOGIC 1612-ET
SKU No.	CL188ETPEINT	CL258ETPEINT	CL410ETPEINT	CL612ETPEINT	CL1012ETPEINT	CL1612ETPEINT
EAN	8435394787589	8435394787596	8435394787602	8435394787619	8435394787626	8435394787633

SPECIFICATIONS

Wire Range (mm ²)	1.5	2.5	4.0	16	10	16
Dimension	Ø4.5xL14.6	Ø5.1xL15.4	Ø5.5xL17.4	Ø9.4xL22.2	Ø8.4xL21.5	Ø9.4xL22.2

PACKAGING INFORMATION

Plastic Bag with Eurohole - 50pcs

ARTICLE	C-LOGIC 2516-ET
---------	-----------------

SKU No.	CL2516ETPEINT
---------	---------------

EAN	8435394787671
-----	---------------

SPECIFICATIONS

Wire Range (mm ²)	25
-------------------------------	----

Dimension	Ø11.8xL29
-----------	-----------

PACKAGING INFORMATION

Plastic Bag with Eurohole - 50pcs



APAC

MGL APPA CORPORATION ✉ cs.apac@mgl-intl.com
Flat 4- 1, 4/F, No. 35, Section 3 Minquan East Road,
Taipei, Taiwan
Tel:+886 2-2508-0877

CANADA & USA

MGL AMERICA INC. ✉ cs.na@mgl-intl.com
6509 Northpark Blvd Unit 400, Charlotte, NC 28216 USA
Tel:+1833 533-5899

EMEA

MGL EUMAN S.L. ✉ cs.emea@mgl-intl.com
Parque Empresarial Argame, 33163 Morcin.
Asturias, Spain.
Tel: +34 985-08-18-70

MEXICO & LATAM

MGL LATAM S.A DE CV ✉ cs.latam@mgl-intl.com
Colonia Industrial Vallejo Del. Azcapotzalco 02300,
Mexico D.F
Tel: +1 833-533-5899

UNITED KINGDOM

POWER PROBE GROUP LIMITED ✉ cs.uk@mgl-intl.com
14 Weller St, London, SE1 1QU, UK
Tel:+34 985-08-18-70

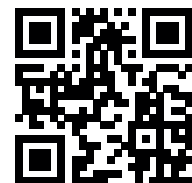

www.dlogic-intl.com

An **MGL** Brand
www.mgl-intl.com